



PERSONAL/BUSINESS WAREHOUSE FOR SALE OR LEASE: STARTING AT \$222/SF

LOCATION: 5378 & 5388 Ronald Reagan Blvd, Johnstown CO 80534
SIZING: 1,406 SF - 2,720 SF
AVAILABLE UNITS: 45 Units
SALE PRICE: Starting at \$222/SF
LEASE RATE: \$19.75/SF NNN

NO GROUND LEASE!

TAKING RESERVATIONS NOW

\$7.5K UPGRADE CREDIT FOR FIRST 10 BUYERS*

**Contact broker for more information*

AVAILABLE NOW

**Buyer co-op fee offered - to be disclosed & agreed upon at time of contract*



KEY FEATURES

GENERAL INCLUSIONS

- Heated and air conditioned
- 14' x 14' overhead doors
- 100 Amp 120/208v 3-Phase electrical panel
- Ceiling height is 20' minimum, slopes up to 24'
- Bathroom included in each unit
- Wide drive aisles
- LED - Energy Efficient Lighting
- Electric & tankless water heater
- Mezzanine / Loft

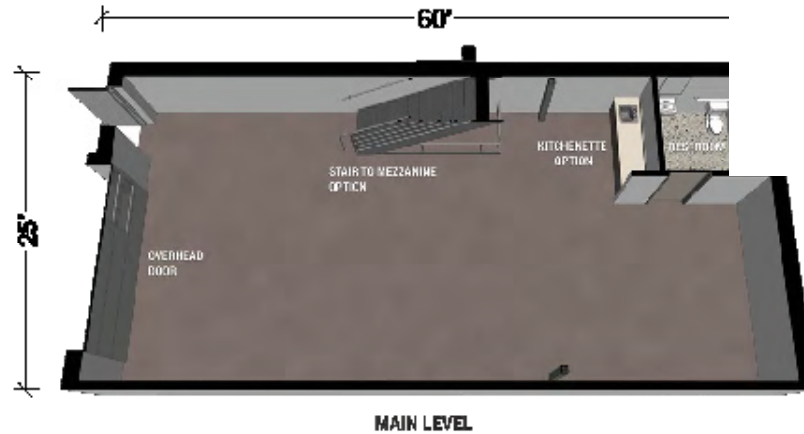
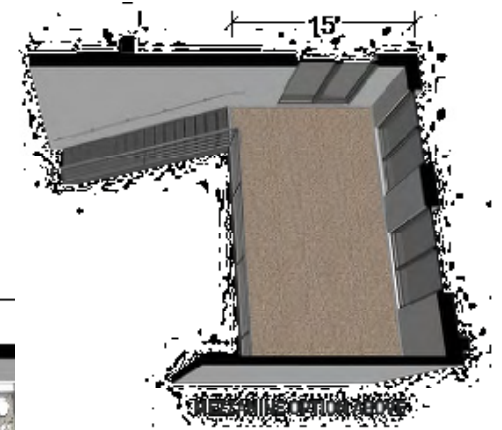

CUSTOMIZATION OPTIONS

- Epoxy coated floors
- Wet Bar / Sink
- Oversized Ceiling Fans
- Interior Finishes and/or Buildout to Suit

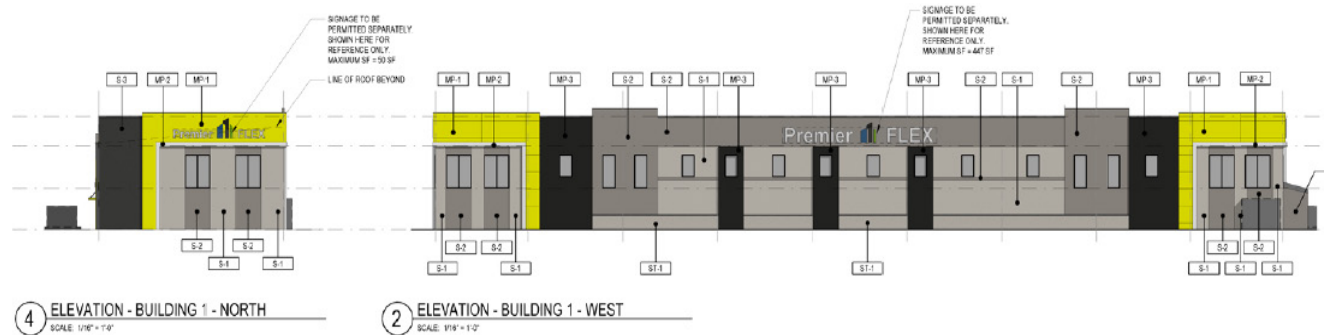

KEY FEATURES

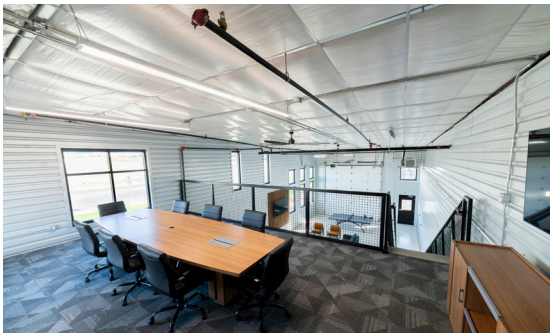
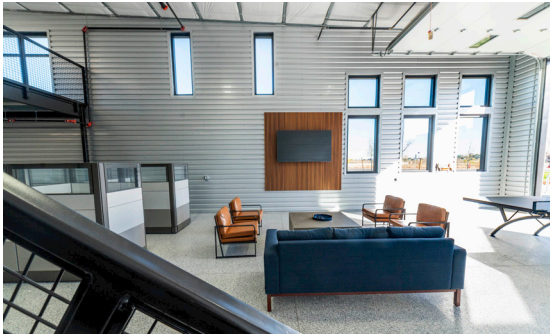
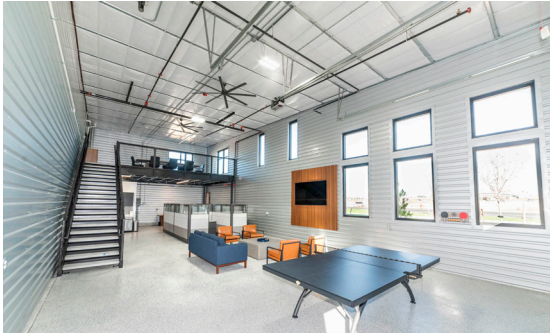

FINANCING

Choose your lender or finance your purchase through Premier Flex's preferred project lender

OWNERSHIP

Get the true benefits of ownership -
Own your unit without encumbrances:
no ground lease

RESALE VALUE

Why pay a landlord rent every month?
Pay yourself and benefit from long
term appreciation offered by this
A+ location

INVESTMENT

Your investment is protected
through a professionally managed
association and condo documents
that tightly control the quality of
uses within the project

SITE MAP



VICINITY MAP



BUILDING A

RISER
151.7 SF

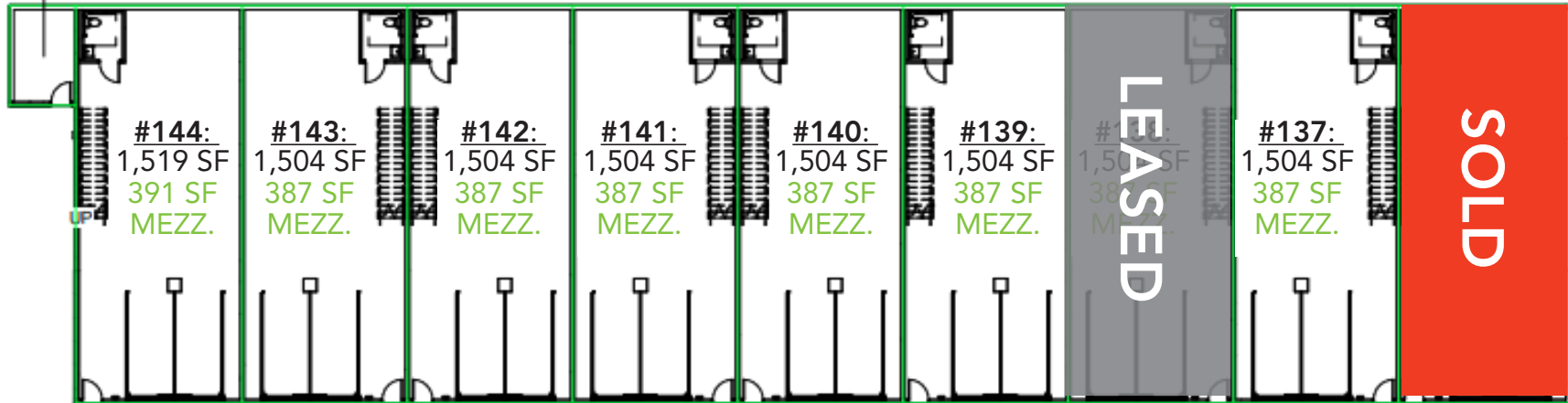

BUILDING B

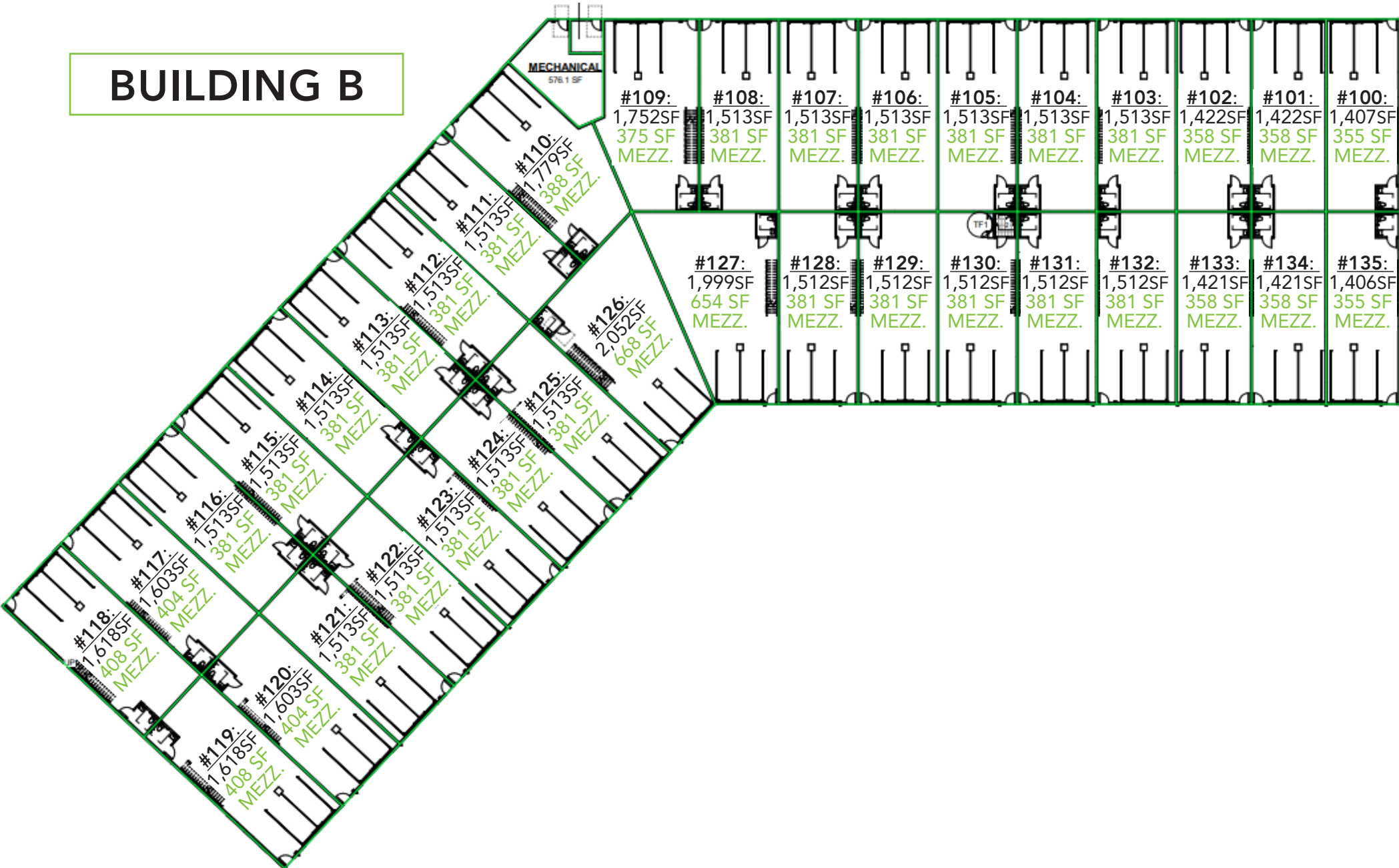

UNIT PRICING*

UNIT	SIZE	SALE PRICE
100	1,762 SF	\$543,438.00
101	1,780 SF	\$528,753.00
102	1,780 SF	\$528,753.00
103	1,894 SF	\$531,168.00
104	1,894 SF	\$531,168.00
105	1,894 SF	\$531,168.00
106	1,894 SF	\$531,168.00
107	1,894 SF	\$531,168.00
108	1,894 SF	\$531,168.00
109	2,127 SF	\$530,538.00
110	2,167 SF	\$531,903.00
111	1,894 SF	\$531,168.00
112	1,894 SF	\$531,168.00
113	1,894 SF	\$531,168.00
114	1,894 SF	\$531,168.00
115	1,894 SF	\$531,168.00
116	1,894 SF	\$531,168.00
117	2,007 SF	\$533,583.00
118	2,026 SF	\$549,003.00
119	2,026 SF	\$549,003.00
120	2,007 SF	\$533,583.00
121	1,894 SF	\$531,168.00
123	1,894 SF	\$531,168.00
124	1,894 SF	\$531,168.00
125	1,894 SF	\$531,168.00

UNIT	SIZE	SALE PRICE
126	2,720 SF	\$606,303.00
127	2,653 SF	\$604,833.00
128	1,893 SF	\$531,168.00
129	1,893 SF	\$531,168.00
130	1,893 SF	\$531,168.00
131	1,893 SF	\$531,168.00
132	1,893 SF	\$531,168.00
133	1,779 SF	\$528,753.00
134	1,779 SF	\$528,753.00
135	1,761 SF	\$543,438.00
136	1,947 SF	SOLD
137	1,891 SF	\$531,798.00
138	1,891 SF	LEASED
139	1,891 SF	\$531,798.00
140	1,891 SF	\$531,798.00
141	1,891 SF	\$531,798.00
142	1,891 SF	\$531,798.00
143	1,891 SF	\$531,798.00
144	1,910 SF	\$547,218.00

***Additional savings by excluding mezzanine**

AREA MAP





Premier FLEX

5378 & 5388 Ronald Reagan Blvd, Johnstown CO 80534

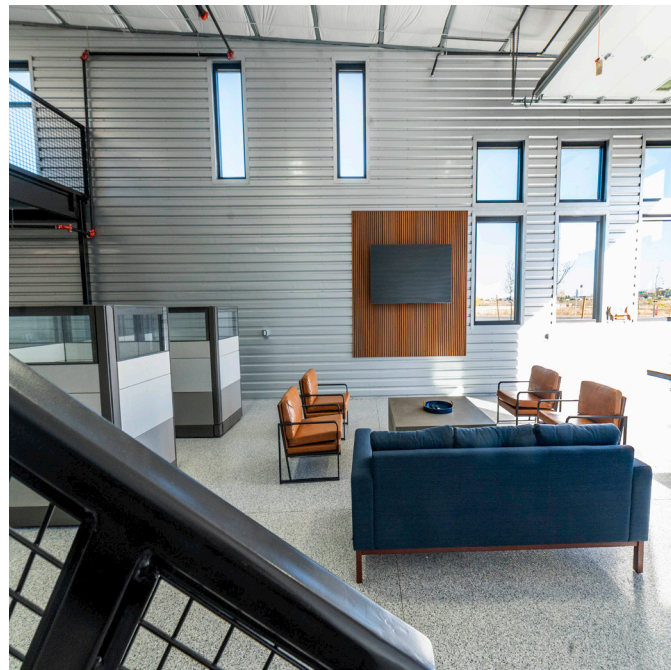
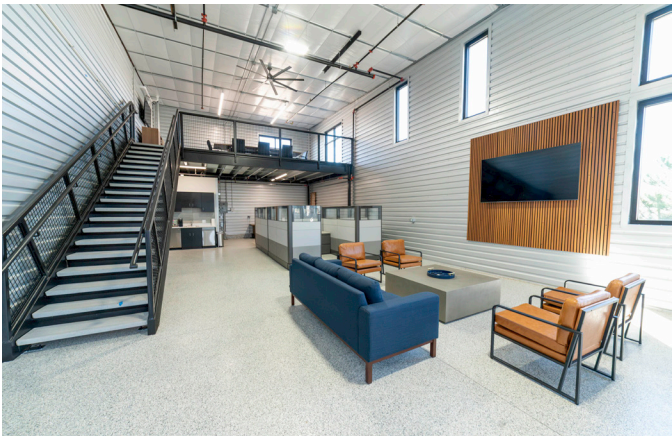

MARC ROBSON / ERIK CAFFEE

125 S Howes Street Suite 500, Fort Collins, CO 80521 • 970-632-5050 • www.waypointRE.com

UNIT UPGRADE PRICING

LARGE FAN

8-blade with remote and wall control



TOTAL: \$3,003

COMBINE UNITS

Long walls - add steel after framing

TOTAL: \$37,763

Short side - remove framing, open wall

TOTAL: \$1,650

FLOOR FINISH PRICING

Clear Seal	\$8,752
Solid Color	\$9,299
Flake	\$10,393
Polished Concrete	\$19,691

ELECTRICAL

Upgrade panel to 200 Amp
**varies based on distance of unit from MDP*

TOTAL: \$4,400 - \$10,450

WET BAR ADD-ON

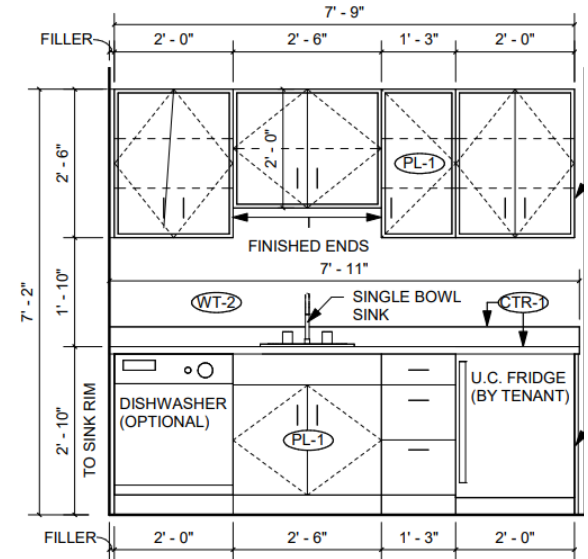

**Exact cabinet configuration and dimensions TBD*

TOTAL: \$18,838



Contact Us



Marc Robson
970-215-4438
mrobson@waypointRE.com



Erik Caffee
970-218-4284
ecaffee@waypointRE.com

WEBSITE



LIFESTYLE
TOUR



The information contained in this offering has been obtained from sources believed to be reliable, however, the accuracy cannot be guaranteed. All potential buyers and/or tenants are hereby advised to perform their own due diligence and independently verify all of the information set forth herein.