

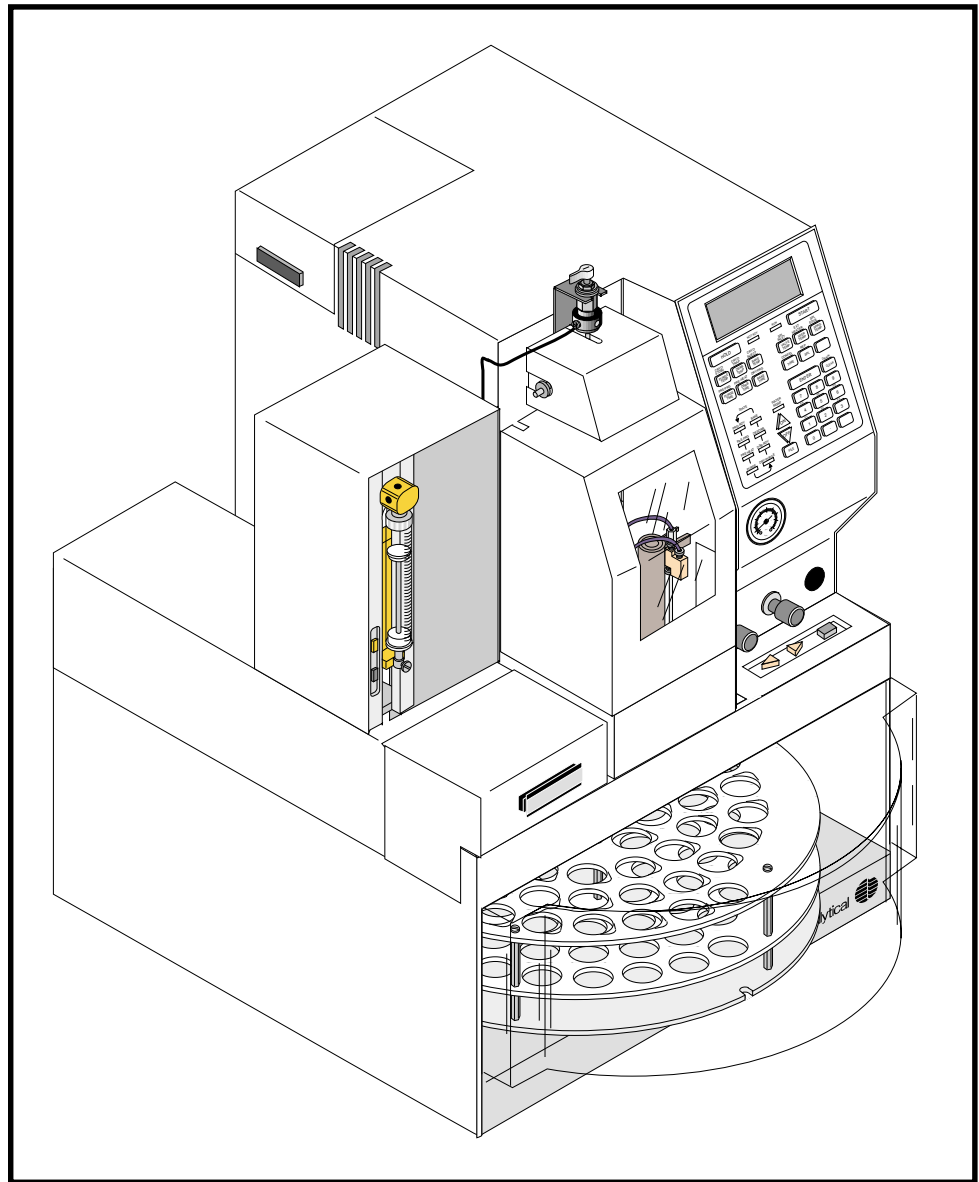

Model 4551 Vial Autosampler Operator's Manual



O·Analytical 

151 Graham Road · P.O. Box 9010 · College Station, Texas 77842-9010 USA
Telephone (979) 690-1711 · FAX (979) 690-0440 · www.oico.com



Notice

The information contained in this document may be revised without notice.

OI Analytical shall not be liable for errors contained herein or for incidental, or consequential, damages in connection with the furnishing, performance, or use of this material.

No part of this document may be reproduced or photocopied, or translated to another language, without the prior written consent of OI Analytical.

Rev. 1.0 — July 1994

Tenax is a registered trademark of Enka Research Institute Arnhem.
Teflon and Viton are registered trademarks of E.I. duPont de Nemours & Co., Inc.
KEL-F is a registered trademark of 3M Co.
Tygon and Norprene are registered trademarks of Norton Co.

OI Analytical Part #235895



Limited Warranty

OI Analytical warrants each Model 4551 Vial Autosampler against defects in materials and workmanship under normal use and service for a period of one (1) year. Equipment installed by OI Analytical is warranted from the installation date; all other equipment is warranted from the ship date. If purchaser schedules or delays installation more than 90 days after delivery, then warranty period starts on the 91st day from date of shipment. This warranty extends only to the original purchaser. OI Analytical will, at its option, repair or replace equipment that proves to be defective during the warranty period, provided the equipment is returned to OI Analytical at the expense of the purchaser. Parts, labor, and return shipment to the customer shall be at the expense of OI Analytical.

Software and firmware designed by OI Analytical for use with a CPU will execute its programming instructions when properly installed on that CPU. OI Analytical does not warrant that the operation of the CPU, software, or firmware will be uninterrupted or error-free.

Consumables, columns, lamps, and high temperature furnaces are warranted for 30 days (parts only) and are not available for coverage under extended warranties or service contracts.

This warranty shall not apply to defects originating from:

- Improper maintenance or operation by purchaser.
- Purchaser-supplied accessories or consumable.
- Modification or misuse by purchaser.
- Operation outside of the environmental and electrical products specifications.
- Improper or inadequate site preparation.
- Purchaser-induced contamination or leaks.

THE FOREGOING WARRANTY IS IN LIEU OF ALL OTHER WARRANTIES, EXPRESS OR IMPLIED, INCLUDING BUT NOT LIMITED TO ANY WARRANTY OF MERCHANTABILITY, FITNESS, OR ADEQUACY FOR ANY PARTICULAR PURPOSE OR USE. OI ANALYTICAL SHALL NOT BE LIABLE FOR ANY SPECIAL, INCIDENTAL, OR CONSEQUENTIAL DAMAGES, WHETHER IN CONTRACT, TORT, OR OTHERWISE.

Any service requests or questions should be directed to the Customer Service Department at 1-800-336-1911.



Table of Contents

Chapter 1: Introduction

Principle of Operation	1
Features	1
Specifications	2

Chapter 2: Description of Components

The Complete System	5
Exterior Components	6
4551 Back Panel	8
Needle Drive Assembly	10
Interior Components	11

Chapter 3: Installation

Materials Needed	13
Unpacking and Positioning the Instrument	13
Installation	14
Preparing the Carrousel	19
Confirming Proper Installation	21

Chapter 4: Operation

Model 4551 Keypad	23
Added States	24
Programming the Model 4551 for Daily Analyses	25
Operation of the Model 4551 with the Model 4560	30

Chapter 5: SIM/Spiker Option

SIM/Spiker Option Features	33
Installing the SIM/Spiker Option	33
Programming the SIM/Spiker Option	36
Loading the SIM/Spiker	36

Chapter 6: Maintenance

Cleaning Procedures	39
Replacement Procedures	40

Chapter 7: Troubleshooting

Model 4551 Troubleshooting Chart	45
SIM/Spiker Option Troubleshooting Chart	47

Chapter 8: Replacement Parts

Model 4551 Vial Autosampler Parts	49
SIM/Spiker Option Parts	51



Appendix

4560 Keystrokes, Visual	55
Configuration Menu	58
Sample/Replicate Menus	60
Plumbing Schematic	61
SIM/Spiker Option Injection Sequence	62



Chapter 1

Introduction

The Model 4551 Vial Autosampler is a liquid-sample-transfer instrument designed to transfer a specified sample amount from a standard USEPA-approved 40-mL volatile organic analysis (VOA) vial to a common sparge vessel on the Model 4560 Sample Concentrator. When combined with the Sample Concentrator, the Autosampler fully automates the analysis of up to 51 samples and one priority sample. The Model 4551 Autosampler uses minimal benchspace, as it is easily Dockable™ with the Model 4560 Sample Concentrator.

Note: If interfacing the Model 4551 to an existing OI Analytical Model 4460A Sample Concentrator, supplemental instructions are included with the required Interface Kit (Part #237487). The 4460A will not interface to the Model 4551 without this kit.

The 4551 can also interface to an OI Analytical DPM-16. Supplemental instructions are included in the required 4551 to DPM-16 Interface Kit (Part #237495). The DPM-16 will not interface to the Model 4551 without this kit.

Applications for the Model 4551 include:

- USEPA 502.1, 502.2, 503.1, 524.1, 524.2
- USEPA 601, 602, 603, 624

Principle of Operation

The Model 4551 uses a unique spiral-design carousel containing 51 sample positions and one priority sample position. Sequentially, samples are moved into position under a needle-piercing assembly, the needle is lowered to pierce the septum, the vial is pressurized with an inert gas, and the sample is transferred to a calibrated sample loop. With a valve rotation, the same gas is then used to transfer the sample aliquot to the sample concentrator's sparge vessel. As the sample concentrator starts purging, the sample is transferred and the analysis begins. When the desorption of the sample to the GC is complete, the sample is automatically drained from the sparger and the Model 4551 performs a programmable number of rinses/washes of the sample pathway and sparge vessel. A purged source of water is used for rinsing the sample lines in the system, and also provides water to run blanks at programmable intervals during a sample sequence.



Features

- Automatic sampling of up to 51 USEPA-approved VOA vials (40 mL) plus one priority sampling position.
- The Model 4560 Sample Concentrator docks directly with the Model 4551 chassis to minimize benchspace requirements.
- Programmable rinses and blanks, through the Model 4560 keypad, provide maximum flexibility.
- Optional SIM/Spikers available for automated standard/surrogate addition. (Up to two SIM/Spikers may be added for up to two different sampling intervals.)
- Can link to OI Analytical discrete multisamplers (DPM-16/MPM-16) for solids sampling capability.
- Transfers water or lightly particulated water samples with no system clogging.
- Spiral-design carrousel optimizes septum-piercing accuracy.
- Removeable, lightweight sample carrousel makes sample loading/unloading easy.
- Uses the Model 4560 Sample Concentrator's Infra-Sparge™ Sample Heater to allow sample heating with direct temperature feedback.
- Easily configured through the Model 4560 Sample Concentrator keypad.
- Motorized needle drive assembly transfers sample automatically from a closed vial to the sparge vessel via a 5-mL or 25-mL calibrated sample loop.
- Immediate replicate sampling from the vial is automatic to protect sample integrity.
- Sampler senses and skips empty vial positions automatically.
- Allows priority vial insertion during a sample sequence without interrupting the sequence.
- Calibrated loop injection of a sample maximizes accuracy and repetition of sample volume.
- Easily changeable sample loops minimize contamination and allow 5 mL or 25 mL sample volumes.



Specifications

System Dimensions (4551/4560)

- 16.75"D x 15.5"W x 23.5"H
- Footprint - 260 in²

4551 Dimensions

- 16.75"D x 15.5"W x 12.25"H
- Footprint - 260 in²

4551 Weight

- 42 lbs

Vial Specifications

- Capacity: 51 + 1 priority vial (wash and waste stations are standard)
- Size: 40 mL VOA vials; 95.25 mm x 27 mm

Sample Loop

- 5 mL, 1/8", coil shape
- 25 mL, 1/8", coil shape (optional)

Sample Loop Valve

- Electrically actuated
- 6-port, 60° rotation
- Aluminum body, Teflon® plug, KEL-F® seat

Sample Transfer Pathway

- 7", 2-hole, stainless steel needle
- 1/16" O.D. x .040" I.D. x 11" PEEK tubing
- 1/16" O.D. x .040" I.D. x 20.5" Ni tubing

Electronic Control (through 4560)

- 80188 microprocessor
- 128K ROM
- 32K RAM with battery backup
- Tactile, elastomeric keypad

Performance Specifications

- Sample transfer accuracy better than $\pm 0.3\%$

Communications with 4560

- O•I•NET™ network interface for inter-instrument communication

Gas Requirements

- 99.999% (UHP) He or N₂

Power Requirements

- 115/230 VAC (switch-selectable) ($\pm 10\%$)/50/60 Hz



Programmable Parameters with 4560

- Washes (rinses) per sample
- Blank frequency
- Blank quantity
- Standard injection/Surrogate intervals
- Sample volume (5 or 25 mL)
- Loop fill time
- Loop transfer time
- Needle depth (70-100%)
- Replicate number
- Sample start position
- Sample end position

Major Options

- Single or dual standards injection module (SIM/Spiker)
- Vial cooling option (separate documentation is included with this option)
- 25 mL Sample Loop



Chapter 2

Description of Components

The Complete System

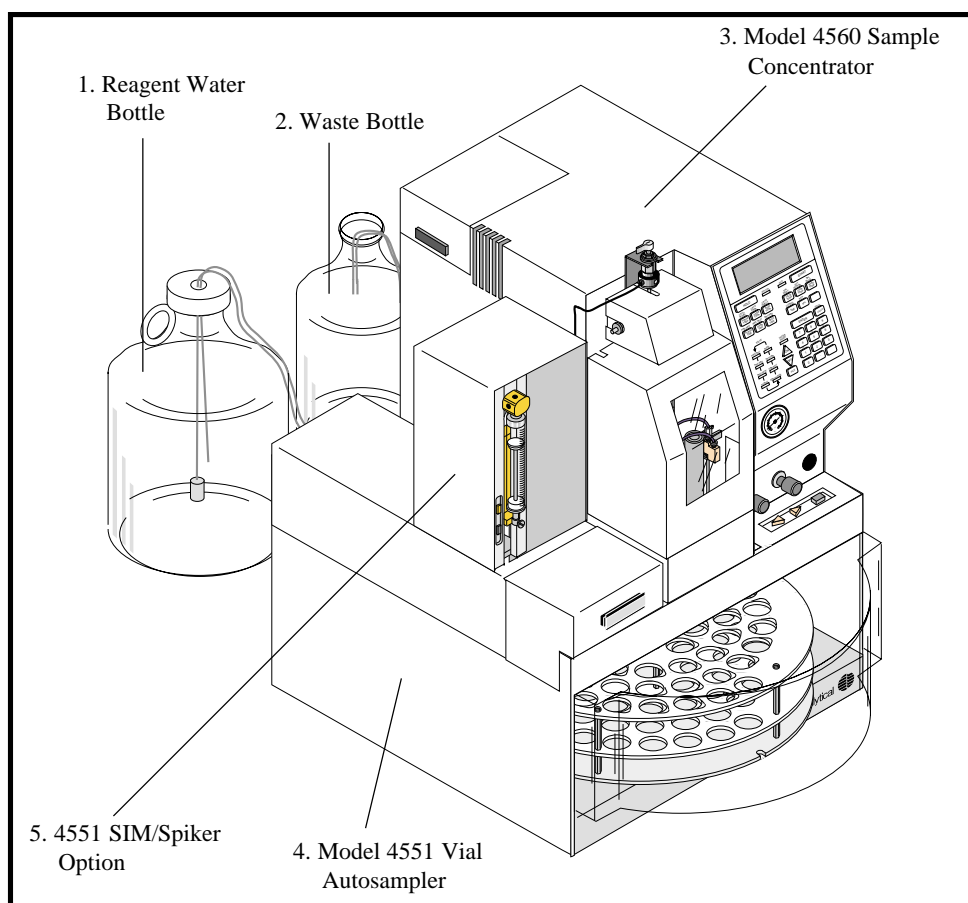

Figure 2.1. Model 4551 with Model 4560 and SIM/Spiker Option

- 1. Reagent Water Bottle** supplies the DI water used for the wash or blank sequences.
- 2. Waste Bottle** (not supplied) receives drained wash water, blank water, sample waste, and SIM waste.
- 3. Model 4560 Sample Concentrator** docks to the chassis of the 4551.
- 4. Model 4551 Vial Autosampler** holds up to 51 samples +1 priority position (see Figure 2.2).
- 5. SIM/Spiker Option** is used to automatically add a standard or surrogate. Up to two SIMs may be added.



Exterior Components

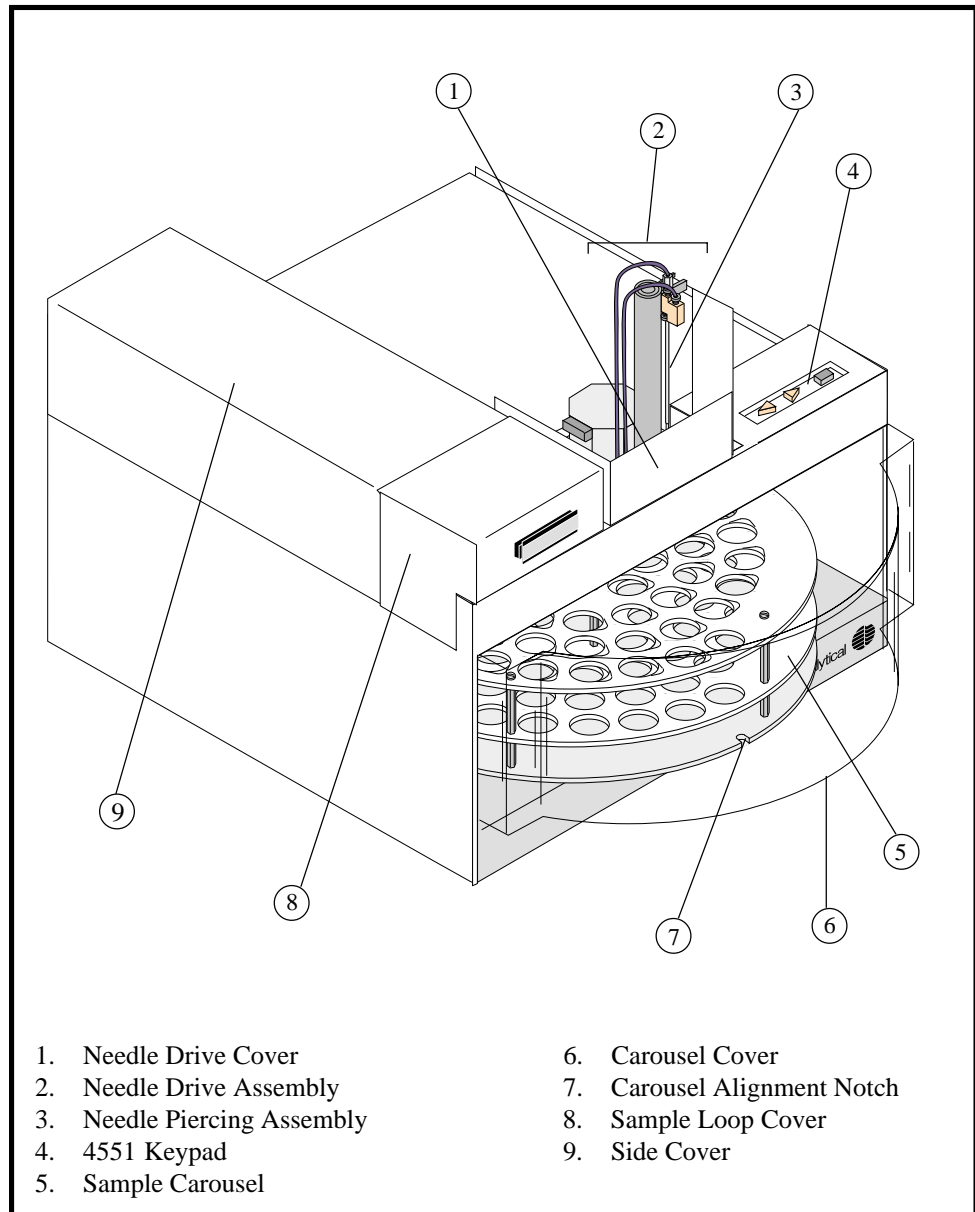

Figure 2.2. Model 4551 Front View

- 1. Needle Drive Cover** is a snap-on cover that protects the needle drive assembly.
- 2. Needle Drive Assembly** raises and lowers the needle piercing assembly (see Figure 2.4).
- 3. Needle Piercing Assembly** is a stainless steel coaxial needle assembly, including a side-hole septum-piercing needle and vial-pressurizing needle sleeve that pierces the sample vial to extract the liquid sample.



4. **4551 Keypad** is used to define functions including load, unload, priority, forward, reverse, wash station calibration, and home position calibration.
5. **Sample Carousel** holds up to 52 (51 + priority) samples, a wash vial, and a waste vial.
6. **Carousel Cover** protects the samples and the operator during operation.
7. **Carousel Alignment Notch** is used to align the carousel into the correct position.
8. **Sample Loop Cover** protects yet allows easy access to the sample loop and valve.
9. **Side Cover** provides housing for the AC power board, transformer, peristaltic sample pump, reagent water pump, and gas distribution manifold. A modified cover is provided with the SIM/Spiker option (Part #242008), which replaces this cover to allow SIM mounting.



4551 Back Panel

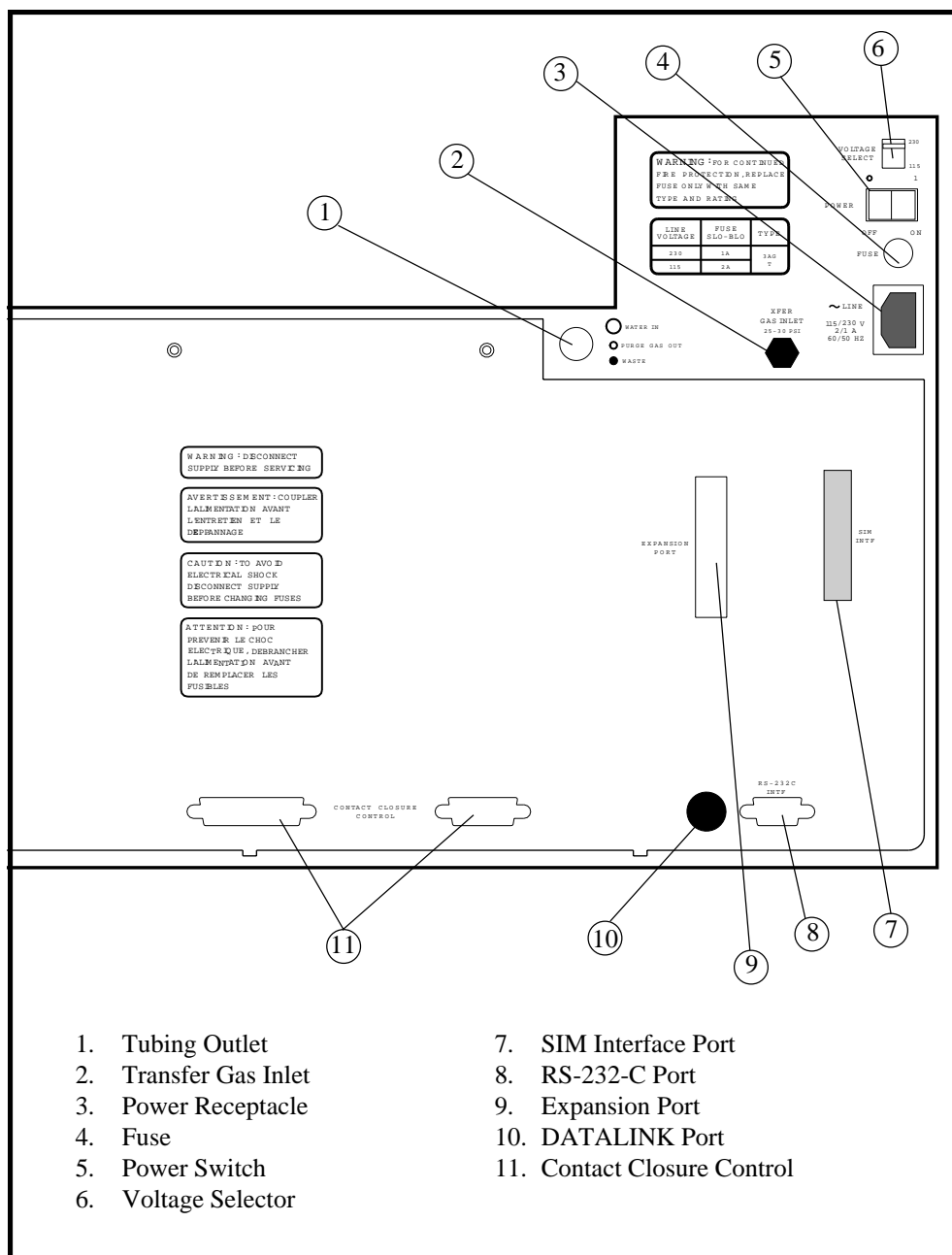

Figure 2.3. 4551 Back Panel

- Tubing Outlet** provides a passageway for the Water In, Purge Gas Out, and Waste lines. The Water In line routes from the reagent water bottle. The Purge Gas Out line runs to the reagent water bottle, and the Waste line routes all excess sample from the pump to the waste bottle.
- Transfer Gas Inlet** is where the 1/8" copper tubing from the UHP He or N₂ tank, *regulated to 25-30 psi*, connects sample transfer gas to the 4551.
- Power Receptacle** receives the appropriate power cable provided in the Start-up Kit, 110 or 220 VAC (±10%).
- SIM Interface Port**
- RS-232-C Port**
- Expansion Port**
- DATALINK Port**
- Contact Closure Control**



4. **Fuse** protects the 4551 from electrical damage. (If fuse replacement is necessary, use only a 2 amp 3 AG T slo-blow fuse).
5. **Power Switch** turns the 4551 power on and off.
6. **Voltage Selector** selects the 4551 operating voltage based on incoming line voltage.
7. **SIM Interface Port** connects the 4551 to the SIM/Spiker option with the ribbon cable included with the SIM/Spiker.
8. **RS-232-C Port** allows 4551 programming through a computer. Contact OI Analytical for specific information.
9. **Expansion Port** (not currently used) allows modification for future 4551 options.
10. **DATALINK Port** allows 4551 and 4560 communication through O•I•NET.
11. **Contact Closure Control** allows 4551 communication with sample concentrators other than the Model 4560. Contact OI Analytical for specific information, if necessary.

Note: OI Analytical does not guarantee proper operation of the 4551 with non-OI sample concentrators. It is the operator's responsibility to identify communication pathways between the 4551 and non-OI instruments.



Needle Drive Assembly

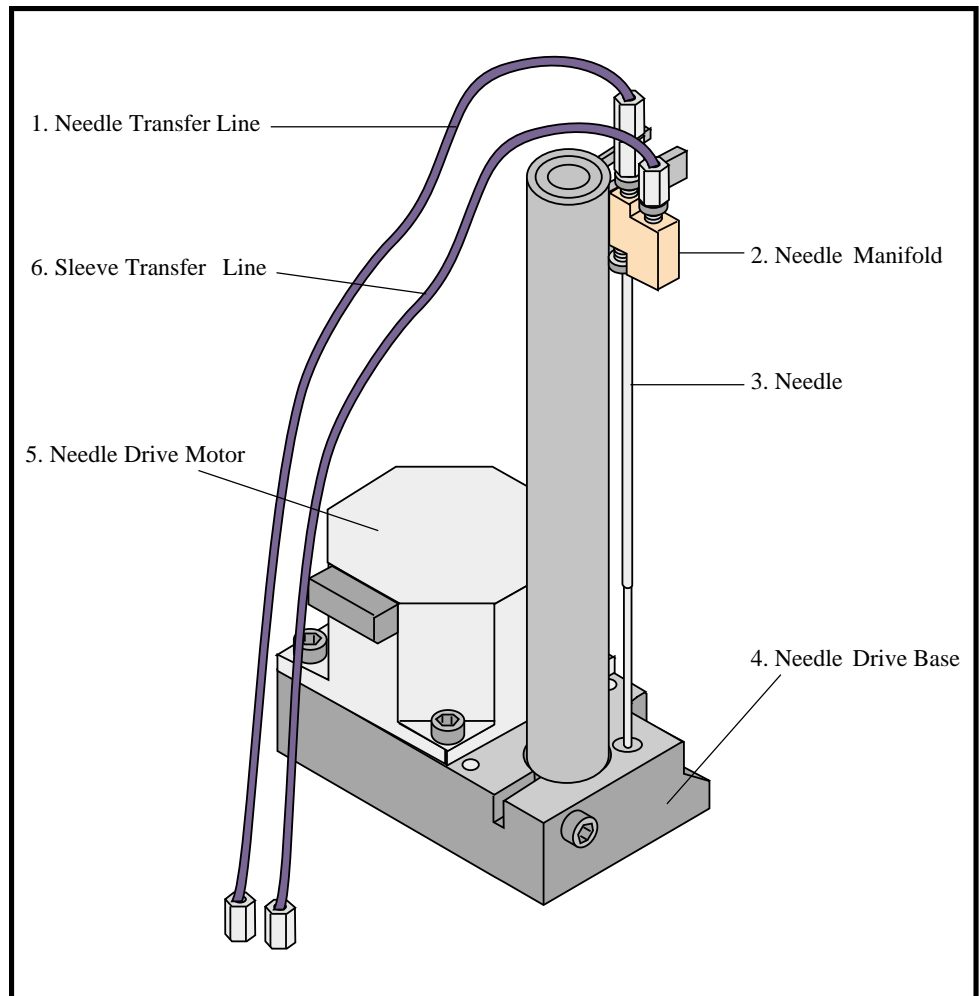

Figure 2.4. Needle Drive Assembly

1. **Needle Transfer Line** is the transfer pathway for liquid sample, wash water, and blank water from the Needle Drive Assembly to the Sample Loop.
2. **Needle Manifold**, a floating manifold, facilitates connection of the Needle and Sleeve Transfer Lines to the Needle Drive Assembly.
3. **Needle** (septum-piercing needle) automatically lowers to draw sample out of the carousel vials.
4. **Needle Drive Base** is the base on which the Needle Drive Assembly is mounted.
5. **Needle Drive Motor** provides power to the Needle Drive Assembly.
6. **Sleeve Transfer Line** is the transfer pathway for gas supplied to the sample vial during loop fill, preventing a vacuum from forming in the vial.



Interior Components

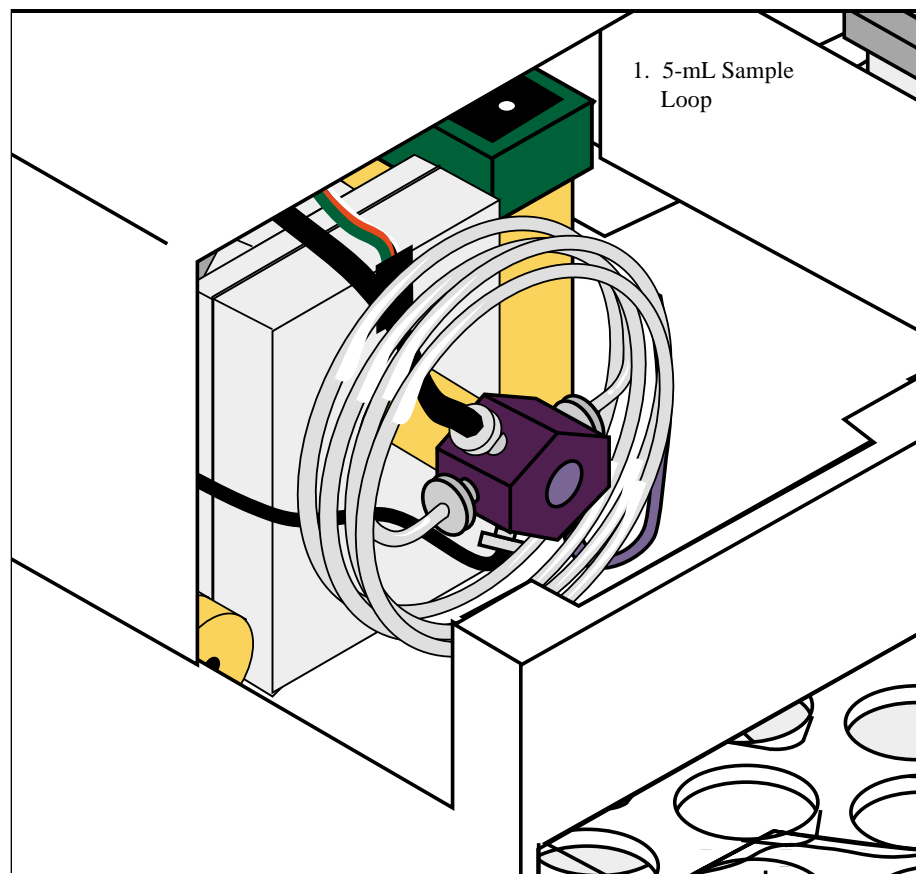

Figure 2.5. 5-mL Calibrated Sample Loop

1. **Calibrated Sample Loop** holds 5 or 25 mL of sample, wash water, or blank water for transfer from the 4551 to the sample concentrator.
2. **6-port Loop Valve** is a 6-port aluminum body, Teflon plug, KEL-F seat loop injection valve that rotates to direct the sample flow path.
3. **Loop Valve Actuator** rotates the 6-port valve 60° from its home position and back, placing the sample loop in either the loop fill path or the sample transfer path.



Notes



Chapter 3

Installation

This chapter describes the basic installation procedure for connecting the Model 4551 Vial Autosampler to a Model 4560 Sample Concentrator.

Failure to complete all sections of the installation procedure may result in incomplete installation and improper operation of the Model 4551 Vial Autosampler.

Note: If interfacing the Model 4551 to an existing Model 4460A Sample Concentrator, supplemental instructions are included with the required Interface Kit (Part #237487). The Model 4460A will not interface to the Model 4551 without this kit.

The Model 4551 can also interface to an OI Analytical DPM-16. Supplemental instructions are included in this kit (Part #237495). The DPM-16 will not interface to the Model 4551 without this kit.

Materials Needed

The following items required for installation are not provided with the Model 4551 Start-up Kit. Verify proper operation and checkout of the Model 4560 Sample Concentrator before installing the Autosampler.

- Waste bottle (> 4-L capacity)
- 3/8" x 7/16" open-end wrench
- Cylinder of ultrahigh purity (UHP-99.999%) He or N₂ (reg. 25–30 psi)
- Gas regulator (25–30 psi); SS diaphragm recommended
- Appropriate gas scrubbers
- Flathead screwdriver

Unpacking and Positioning the Instrument

To prepare the Model 4551 for installation:

1. Unpack the Autosampler and position it on the side of the GC nearest the injection port.
2. Remove any additional packing materials, as necessary, from the Autosampler mainframe. (Save all packing materials until proper operation of the Autosampler is verified.)



3. Turn the Model 4560 Sample Concentrator power off, if applicable. If a sparge vessel door is on the Model 4560, remove it before mounting the Model 4560 on the Model 4551 (see “Door Installation” in this chapter).
4. Before mounting the Model 4560, bend the Ni line on the Model 4551 platform (bent down and back for shipping purposes) up and forward toward the operator. Once the line is clear, align the Model 4560’s rubber feet with the white nylon screws on the Autosampler platform and mount the Model 4560 on the Model 4551.

Note: OI Analytical does not support docking any non-OI Analytical sample concentrator on the Model 4551 Vial Autosampler. If a non-OI Analytical sample concentrator is present, it should be positioned immediately adjacent to the Autosampler to allow efficient routing of sample transfer plumbing.

5. Position the provided reagent water bottle behind the Autosampler to allow routing of WATER IN and PURGE GAS OUT lines from the back panel of the Autosampler.
6. Position a waste bottle (not provided) in a suitable location behind the Model 4551 to allow waste line routing from the back panel of the Autosampler and the Model 4560.

Note: The waste bottle should be positioned level with or lower than the Model 4551 to allow proper drainage.

Installation

Electrical Connections (see Figure 3.1)

1. Select the proper voltage (115 VAC/230 VAC) using the two-position voltage selector on the back panel of the Autosampler.
2. Connect the DATALINK port on the back of the Autosampler to the DATALINK port on the sample concentrator CPU card (see Chapter 2, “Description of Components,” in the *Model 4560 Sample Concentrator Operator’s Manual*) using the three foot BNC cable (Part #235515) provided in the Start-up Kit.
3. Plug the appropriate end of the Autosampler power cord into the power receptacle on the Autosampler back panel. Plug the other end into an appropriate grounded outlet, 110/220 VAC ($\pm 10\%$).

CAUTION:
Transfer gas pressure at 25-30 psi is mandatory for proper operation and calibration of the 4551.



6. Route the brown WASTE line from the Model 4551 back panel to the waste bottle.
7. Route the DRAIN line from the Model 4560 back panel to the waste bottle.

Note: Verify that the waste bottle is level with or lower than the Model 4551 to allow proper drainage.

Installing the 4-way Sample Valve on the Model 4560 (see Figure 3.2)

To replace the 3-way sample valve on the Model 4560 Sample Concentrator (see Chapter 2, “Description of Components,” of the *Model 4560 Operator’s Manual*) with the 4-way sample valve (Part #237180) provided, perform the following steps:

1. Verify that the Model 4560 power is off.
2. Disconnect the drain line from the 3-way sample valve by finger-loosening the knurled nut.
3. Remove the purge/drain needle from the bottom of the 3-way sample valve by loosening the knurled fitting.
4. Loosen the sample valve bracket by loosening the two screws holding it to the Model 4560.
5. Remove the sample valve bracket by sliding it up, leaving the screws attached to the Model 4560. Once the bracket is removed, loosen and slide the 3-way sample valve forward to remove it from the bracket.
6. Place the 4-way sample valve (included in the Start-up Kit) on the sample valve bracket with the ports oriented at 3, 6, and 9 o'clock.
7. Slide the bracket back onto the two screws.
8. Reinstall the purge/drain needle into the bottom of the 4-way sample valve.
9. Retighten the screws to secure the bracket to the Model 4560.
10. Reconnect the drain line to the 4-way sample valve and finger-tighten the connecting nut.
11. Remove the Luer-lock fitting from the 3-way sample valve and place it on the 4-way sample valve at the 6 o'clock position.

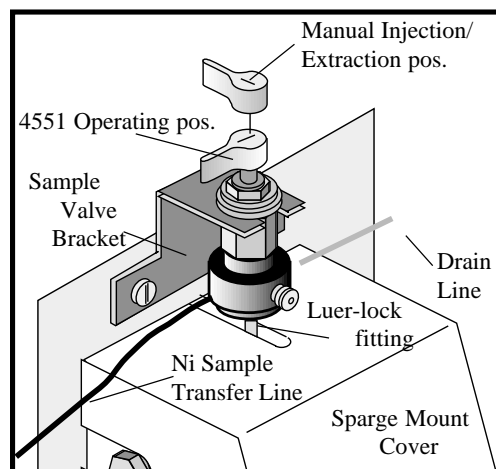

Figure 3.2. Model 4560 4-Way Valve



12. If there is a SIM/Spiker, “SIM/Spiker Option” in Chapter 5 for line plumbing and SIM installation, disregard the following steps, and continue with “Installing the Sparge Vessel Door.” If there is no SIM/Spiker, continue with the following steps.
13. Remove the sample loop cover from the Model 4551.
14. Connect the Ni sample transfer line extending from the 4 o'clock position of the Model 4551 6-port loop valve to the 9 o'clock position on the Model 4560 4-way sample valve.
15. Replace the Model 4551 sample loop cover.

Installing the Sparge Vessel Door (see Figure 3.3)

If a Sparge Vessel Door is installed on the Model 4560

If the Infra-Sparge™ Sample Heater option is installed on the Model 4560, there will be a sparge vessel door on the Model 4560. This door must be removed and replaced with the new door (Part #257428) included in the Model 4551 Start-up Kit, to accommodate the needle drive assembly of the Model 4551.

To remove the Model 4560 sparge vessel door and install the new door:

1. Loosen, but do not remove, the two thumbscrews (Part #230938) holding the sparge vessel door hinge to the Model 4560, and slide the door off.
2. Line up the replacement door hinge slots with the thumbscrews and slide the new door on. Tighten the thumbscrews with a flathead screwdriver.
3. Line up the slot on the door frame with the door switch on the Model 4560.
4. The magnetic latch already installed on the Model 4560 can be left in place for use with the new door.

If no Sparge Vessel Door is installed on the Model 4560

To install a door (Part #257428) on the Model 4560:

1. Insert the two thumbscrews (Part #230938) included in the Model 4551 Start-up Kit into the corresponding holes on the left side of the Model 4560 front panel. Screw the thumbscrews in about halfway.
2. Line up the door hinge slots with the thumbscrews and slide the door hinge into place.
3. Tighten the thumbscrews with a flathead screwdriver to secure the hinge.

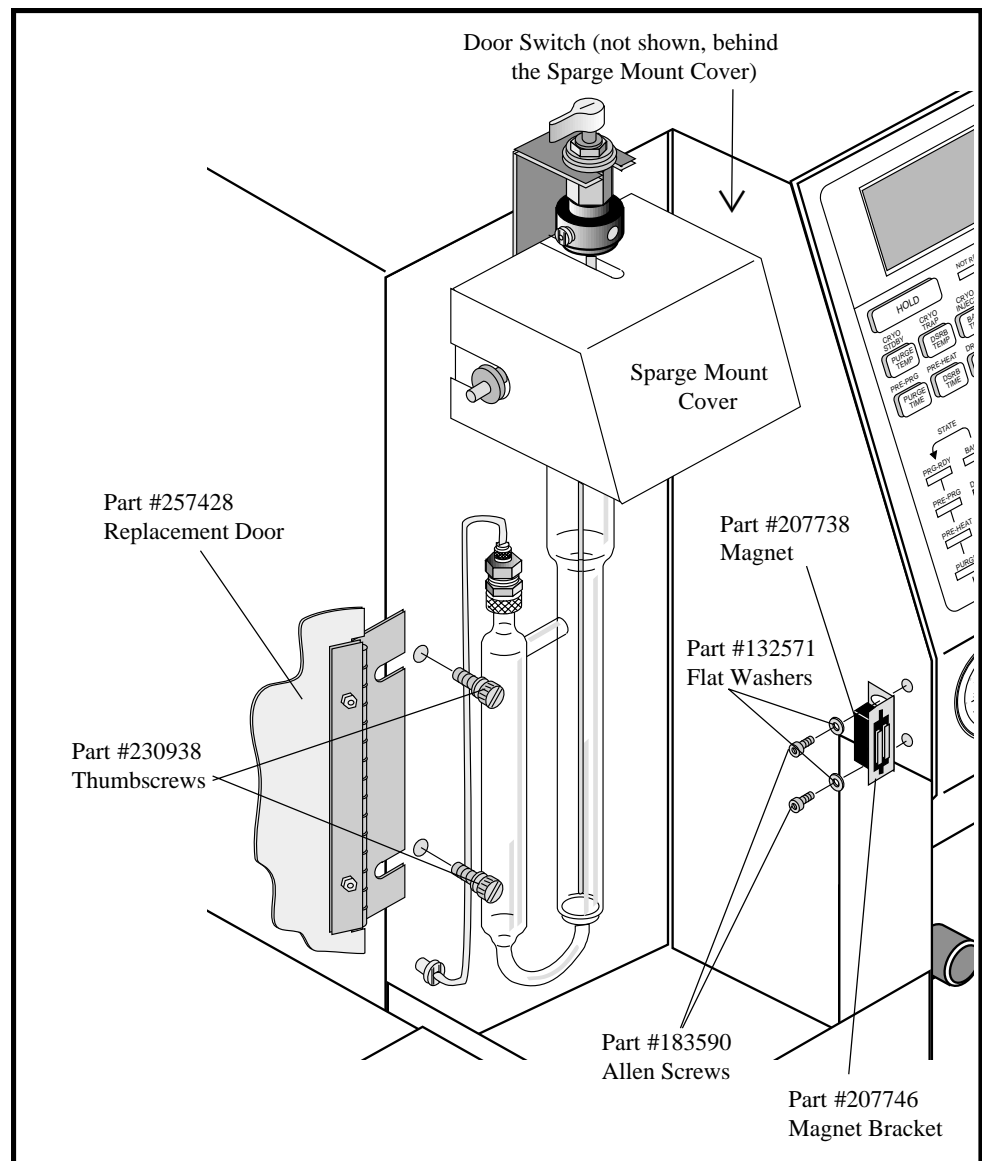

Figure 3.3. Door Installation

4. To install the magnetic latch included in the 4551 Start-up Kit, snap the magnet (Part #207738) into the magnet bracket (Part #207746), then line the bracket holes up with the holes on the Model 4560.
5. Place the flat washers (Part #132571) over the two SS Allen screws (Part #183590) and screw the magnetic latch into place using the 3/32" Allen wrench provided.
6. Adjust the slot positions as necessary so the door opens and closes smoothly.



Power Up

1. Install the carousel cover.
2. Turn on both the Model 4560 and the Model 4551 and verify that the Model 4560 passes the automatic self-test.

Note: If using a Sample Concentrator other than the Model 4560, there may be no self-test.

Preparing the Carousel

WASH Station Calibration

The WASH vial, in the WASH position in the carousel, must be calibrated to fill to an appropriate water level. The proper water level is achieved when the pump nearly, *but not completely*, evacuates the wash vessel during blanks or washes.

To program the water level:

1. Disconnect O•I•NET from the Model 4560 by unscrewing the coaxial cable from the DATALINK port on the back panel of the Model 4560.
2. Unload the carousel by pressing the [FWD] key on the Model 4551 keypad twice. Remove the carousel cover and the carousel.
3. Remove the WASH/WASTE vials from the Model 4551 Start-up Kit and rinse them with DI water. Place the vials in the WASH and WASTE station carousel positions.
4. Using organic-free DI water, fill the WASH station vial to the following recommended height: if using a 5-mL sample loop, fill the vial halfway; if using a 25-mL sample loop, fill the vial to 1/2"–3/4" below the top of the vial.

Note: The proper water column height is achieved when the pump nearly, *but not completely*, evacuates the wash vessel during blanks or washes.

5. Replace the carousel, using the alignment notch for proper positioning.
6. Replace the carousel cover.
7. Press any key on the Model 4551 keypad to reload the carousel.
8. Turn off the power to the Model 4551.
9. Holding *both* the [FWD] and [REV] keys down firmly, turn the Model 4551 power back on to begin WASH station calibration.

Note: Hold both keys down firmly or the calibration procedure may not be initiated.

CAUTION:
Be sure to align the carousel properly to avoid needle and/or carousel damage.



10. Release the keys. The Model 4551 will automatically return the carousel to the Priority position, run the pump to empty the loop and lines, and lower the needle into the WASH vial (the needle will remain in the vial for several minutes). The Model 4551 keypad status LED light stops blinking and the needle raises to indicate that the calibration is complete. The WASH station level has been stored in the Model 4551 battery-backed memory.
11. Reconnect O•I•NET by screwing the coaxial cable back into the Model 4560 DATALINK port.

The WASH water level is now calibrated so that the Model 4551 will automatically refill the WASH vial to this water level as necessary during the analysis.

Setting the Carousel Home Position

The carousel must also be set so that each vial septum is centered directly below the needle piercing assembly. This ensures that the needle will consistently pierce the center of each vial septum during the programmed analyses, preventing needle damage and analysis errors.

After setting the initial home position, the carousel home position should not need resetting unless the battery back-up is lost or the battery is replaced.

Note: As a safety feature of the Model 4551, the needle automatically retracts if it hits any solid object before reaching the vial septum. The needle also will not move if the carousel cover is not in position.

To set the carousel to a home position:

1. Disconnect O•I•NET from the Model 4560 by unscrewing the coaxial cable from the DATALINK port on the back panel of the Model 4560.
2. Place a reference vial in the priority position.
3. Turn the Model 4551 power off.
4. Press and hold the [FWD] key on the 4551 keypad. **Continue holding the [FWD] key firmly through the next two steps, until instructed to release it.**
5. Turn the Model 4551 power back on.
6. The carousel will advance to the Priority position (pos. 0) and the needle will lower slightly (see Fig. 3.4). The carousel cover must remain on during this step to allow needle movement.

CAUTION:
Do not expose the carousel to ketones (acetone) or concentrated aromatics as they will disfigure the carousel.

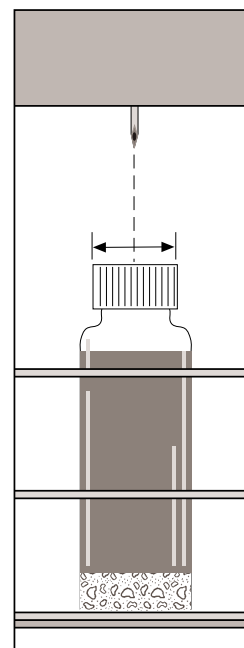

Figure 3.4. Needle Alignment



7. Still holding down the [FWD] key, remove the carousel cover and manually rotate the carousel so that the Priority position vial septum is centered directly beneath the needle (see Fig. 3.4).
8. Release the [FWD] key to store the home position in the Model 4551 battery-backed memory. This position will be stored until reset, or the battery is replaced.
9. Replace the carousel cover and reconnect O•I•NET by screwing the coaxial cable back into the Model 4560 DATALINK port.

Unloading and Reloading the Carousel

1. To unload the carousel, press the [FWD] key twice (double-click, like a mouse). The carousel will rotate out and forward for easy access.
2. Remove the carousel cover.
3. Remove the sample vials or insert new sample vials into position.
4. Replace the carousel cover.
5. To reload the carousel, press any key on the Model 4551 keypad once.

Note: As a safety feature of the Model 4551, the needle will not lower if the carousel cover is not on. Do not attempt to perform any analyses without the carousel cover installed.

Confirming Proper Installation of the Model 4551

To confirm that the Model 4551 has been properly installed, perform a manual wash. (See “Performing a Manual Wash” in Chapter 4, “Operation.”) Watch the process to verify that:

- The WASH station is not completely evacuated, confirming an accurate calibration level.
- All Sample Loop connections are leak-free.
- Full sample transfer, 5 mL or 25 mL, is achieved.

The Model 4551/4560 is ready to be programmed and run. Follow the steps in Chapter 4, “Operation,” to program a sequence.



Notes



Chapter 4

Operation

This chapter provides basic information on the operation of the Model 4551 Vial Autosampler.

Note: The following instructions are for operating the Model 4551 and the Model 4560 Sample Concentrator. Instructions for operating the Model 4551 and the Model 4460A Sample Concentrator are included in the required Interface Kit (Part #237487).

The Model 4551 transfers a specified sample amount from a standard VOA vial to a common sparge vessel on the Model 4560 Sample Concentrator, fully automating the analysis of up to 51 samples plus one priority sample.

The Model 4551 includes all necessary hardware and electronics to interface to the Model 4560, and is easily configured through the 4560 keypad. A SIM/Spiker option is available to provide several auto-injection alternatives. All 4551 commands are sent from the Model 4560 Sample Concentrator through O•I•NET, but limited operation of the Model 4551 is also possible through contact closure control (used with the Model 4460A Sample Concentrator).

Note: Included in the Model 4551 Start-up Kit is a Model 4560 firmware upgrade, Rev. 2.00. If interfacing the Model 4551 to an existing Model 4560, a firmware upgrade may need to be performed. Refer to the installation instructions included with the upgrade. If a new Model 4560 is used, it should already have the Rev. 2.00 (or later) firmware.

CAUTION:
Model 4560 Rev.
2.00 (or later)
firmware is
mandatory for
proper operation
of the Model
4551. The Model
4551 will not
function without
the correct
firmware version.

Model 4551 Keypad

The [PRIORITY] key is normally used only for running Priority samples. (Refer to “Running Priority Samples” later in this chapter for instructions.) Pressing the [PRIORITY] key three times quickly will erase all commands in the 4551 buffer, and may be used to reset the 4551, if necessary.

The [FWD] key rotates the carousel forward to increasing sample position numbers (e.g., sample pos. 1 to sample pos. 51). Pressing the [FWD] key once moves the carousel forward one position at a time. Pressing and holding the [FWD] key rotates the carousel forward until the key is released. Pressing the [FWD] key twice rotates the carousel completely out to allow loading and unloading.

The [REV] key rotates the carousel in reverse to decreasing sample position numbers (e.g., sample pos. 51 to sample pos. 1). Pressing the [REV] key once



rotates the carousel in reverse one position at a time. Pressing and holding the [REV] key rotates the carousel in reverse until the key is released.

The top LED light blinks whenever a key is pressed, confirming that the key was pressed.

The bottom LED light is always illuminated, and blinks when the 4551 is executing a command.

Note: Do not give the Model 4551 further commands until the light quits blinking or the commands may back up, causing unintended operation of the Model 4551.

Added States

When the Model 4560 Sample Concentrator is operating in a run state, the microprocessor advances through a sequence of primary states described in the *Model 4560 Operator's Manual*.

Model 4551 States

The Model 4551 adds the following states to the Model 4560 Sample Concentrator's cycle:

FILLING SAMPLE LOOP	WASH
SIM INJECT	WASH-CPLT
SAMPLE TRANSFER	

The following is a description of these added states:

FILLING SAMPLE LOOP - This state indicates that the sample vial is being pierced and pressurized. Transfer (XFER) gas plumbed to the back of the Model 4551 pushes the sample from the bottom of the vial, through the sample loop, against the restriction of the running peristaltic pump.

SIM INJECT - This state occurs quickly and is not shown on the Model 4560 display. In this state, the 4-way valve of each configured SIM is rotated in-line with the 10-mL standard syringe and the syringe plunger is advanced to fill the valve (some excess goes to the waste bottle).

SAMPLE TRANSFER - During this state, the loop volume is pushed by the transfer gas to the sparge vessel on the Model 4560. The inject time is adjusted so that transfer gas flow continues for a few seconds after the sample is transferred to ensure a complete transfer. The sample passes through the SIM valve(s), if present, on its way to the sparge vessel of the Model 4560. As it does, it sweeps the valve(s) contents along with the sample for effective ISTD/surrogate addition. Sample Purging begins at the start of Sample Transfer.



WASH - After the DESORB state has begun and the Model 4560 has drained the purged sample, the Model 4551 begins cleanup for the next sample. The carousel rotates to the WASTE vial, the needle is lowered, and a flow of transfer gas evacuates any particulates or sample that remains in the Model 4551 needle or plumbing. Next, the needle is raised and the carousel moves to the adjacent WASH position, replenishes the WASH station liquid level, and fills the sample loop with an aliquot of wash water equal to the sample volume. This aliquot is transferred, like a sample, to the sparge vessel and is then automatically drained. This wash process is repeated (including the WASTE evacuation) for the programmed number of WASHES/SAMPLE. The WASH state occurs during DESORB and BAKE and is therefore not shown on the Model 4560 display.

WASH-CPLT (Wash Complete) - This state occurs after BAKE only if the programmed sum of DESORB and BAKE time is less than the time required to complete the total number of programmed washes. The Model 4560 automatically estimates the remaining time required to complete the WASH state. Once programmed washes are complete (regardless of remaining time), the Model 4560 advances to STANDBY for the next sample. If the upcoming sample is a blank, the needle will remain in the WASH station, purging blank water for the remaining time.

Method Sequencing

The Model 4560 has the ability to change vial sequencing parameters for each run. Refer to “Method Sequencing” in Chapter 4, “Operation,” of the *Model 4560 Operator's Manual* for a detailed explanation.

Beginning with Model 4560 Rev. 2.00 firmware, all Model 4551 parameters (including all configuration parameters) in Table 4.1 are stored when a method file is saved in the Model 4560. Beginning with Rev. 2.00, to sequence method files, choose the file number in the sequence ([1]–[5]) and select the method file using the on/off arrows. Since the Autosampler start and end positions are also saved, **avoid overlapping start and end positions when sequencing files.**

Options	ON/OFF	5 mL	25 mL
Wash Quantity	ON	2	2
Blank Quantity, Interval		0,0	0,0
SIM A Interval	OFF	1	1
SIM B Interval	OFF	1	1
Loop Fill Time		0.2	0.5
Loop Transfer Time		0.2	1.0
Needle Depth		95%	95%
Replicate Number		1	1
Sample Start Position		1	1
Sample End Position		51	51

Table 4.1. 4551/4560 Defaults



Programming the Model 4551 for Daily Analyses

To begin an analysis sequence, place the sample vials in the appropriate carousel positions, following the carousel loading procedure described in Chapter 3, “Installation.” Table 4.1 lists default values that appear on the 4560 display when configuring 5-mL and 25-mL sample loop options.

Perform the following steps to begin programming (see “4560 Keystrokes, Visual” in the Appendix for a visual explanation of programming). See Figure 4.1 to view the Model 4560 keypad :

1. Press the 2nd function key (the gold key) and the [TIME] key to reach the CONFIG menu.
2. Choose OPTIONS from the display menu by pressing either arrow key, then [ENTER].
3. Choose 4551 from the display menu by pressing either arrow key, then press [ENTER].
4. Choose ON from the display menu by pressing the up arrow key labelled ON . The 4551 will establish communication with the 4560.
5. Press the [1] key to configure the parameters listed in Table 4.1. The WASH menu will be displayed first.

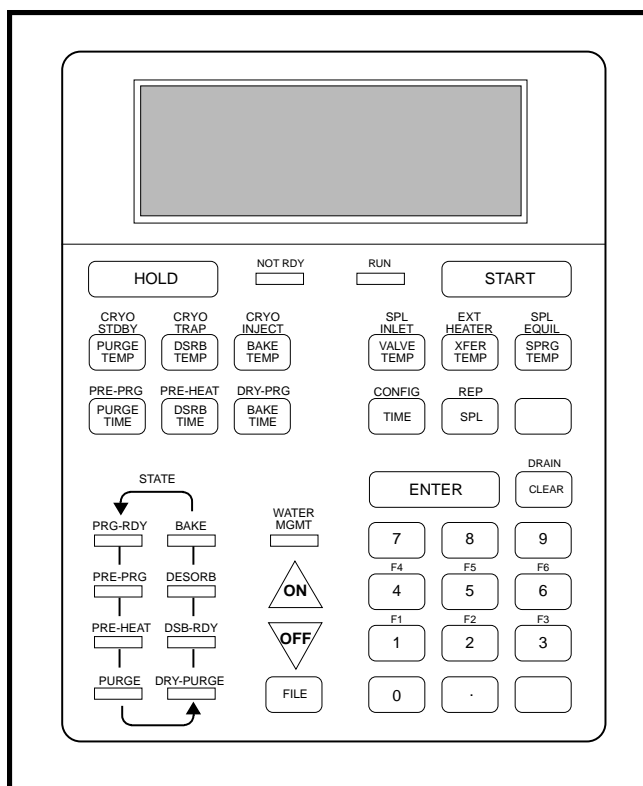

Figure 4.1. Model 4560 Sample Concentrator Keypad



Configuration Menus

Programming Washes

The 4551 WASH feature helps ensure accurate and uncontaminated results by automatically rinsing the Model 4551 transfer lines and Model 4560 sparge vessel after each sample analysis. The following steps set the automatic WASH sequence. The number programmed will be the number of washes run between each sample. Follow all the previous programming steps to reach this menu, then continue:

1. While in the WASH menu, press the up arrow key labelled ON to enable washes.
2. If changing the default quantity, enter the desired quantity using the number keys, then press [ENTER].
3. Press [ENTER] again to advance to the next menu. (If the default intervals are not changed, press [ENTER] only once to advance.)

Note: An asterisk shown on the Model 4560 display indicates that a value has been changed and [ENTER] should be pressed within 5 seconds, or the previous value will remain in effect.

Programming Blanks

The next menu displayed is the BLANKS menu. Blanks may be run at programmable intervals between sample analyses. To program the desired blank quantity and blank intervals, follow all the previous programming steps to reach this menu, then continue:

1. Using the up/down arrow keys to move the cursor between selections, enter the desired blank quantity and interval (if changing the defaults) by pressing the number keys, then press [ENTER].

This menu reads as a sentence; for example,

-“Insert 0 Blanks After 0 Samples” eliminates blanks from the sample sequence.

-“Insert 50 Blanks After 0 Samples” programs 50 blanks before advancing to the first sample in the sequence. This is useful for cleanup when the 4551 is not in use.

-“Insert 2 Blanks After 5 Samples” programs 2 blanks after every 5 samples in the sample sequence. If the SIM interval corresponds with the blank, the blank will be spiked with an Internal/Surrogate standard.

2. Press [ENTER] again to advance to the next menu if the values were changed. (If the default values are not changed, press [ENTER] only once to advance.)



Programming SIM A and SIM B

If a SIM/Spiker option is present, the next menus displayed will be the SIM A and SIM B menus. If there is no SIM/Spiker, these menus will not display. To program the SIM/Spiker option, refer to Chapter 5, “SIM/Spiker Option,” then continue with “Programming Sample Volume.”

Programming Sample Volume

After the SIMs are programmed, the next menu is the SAMPLE VOLUME menu.

Follow all the previous programming steps to reach this menu, then continue:

- Choose the appropriate sample volume corresponding to sample loop size, either 5 mL or 25 mL, by pressing [ON]. Then press [ENTER] to move to the next menu, or press [TIME] to set custom loop fill and sample transfer times.

Customizing Loop Fill/Sample Transfer Times

“Loop fill” is the time that the sample pump runs to fill the sample loop. “Loop Transfer” is the sample transfer time from loop to sparger.

The selection between 5 mL and 25 mL loop size will enter the appropriate loop fill (pump) and loop transfer (sample transfer) times for the selected loop size. To change these default times for loop filling and sample transfer, perform the following steps from the SAMPLE VOLUME menu.

Perform all the previous programming steps to reach this menu, then continue:

1. Press the [TIME] key.
2. Press the up/down arrow keys to move the cursor and the number keys to set new times. Press [CLEAR], then [ENTER] to return to the SAMPLE VOLUME menu.

Programming Needle Depth

The next menu displayed is the NEEDLE DEPTH menu (see Figure 4.2). To program needle depth, enter the percentage the needle will lower into the sample vial. For example, if the depth is set to 70%, the needle will lower 70% into the vial. A depth of 70% is recommended for particulated samples, to prevent large settled particles from clogging the needle.

Note: The Model 4551 sample filter has a 10- μ screen that will filter particulates larger than 10 μ .

1. Enter the value and press [ENTER]. (To demonstrate needle depth from this menu, before pressing any other keys, use the arrow keys to lower the needle into the priority vial position in intervals of 5%.)

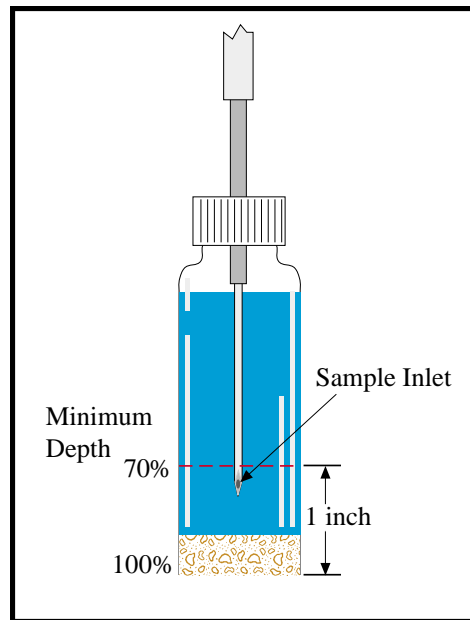

Figure 4.2. Needle Depth

2. Press [CLEAR] repeatedly to return to the main menu (the menu displayed before programming).

Sample Menu

Programming Start and End Positions

For each sample sequence, the operator must enter a start (first) position and an end (last) position corresponding to the actual sample positions marked on the sample carousel.

1. From the main menu, press the [SPL] (sample) key.
2. The Model 4551 SAMPLE menu will be displayed. Using the number keys, enter the START position and the END position of the samples to be analyzed, then press [ENTER].
3. The carousel will move automatically to the new start position, and the display will show the total samples to be analyzed (as a verification), and the current carousel position. Press [CLEAR] key to return to the main menu.

Note: In some instances, the CURRENT value displayed may not match the actual carousel position, or the carousel may not rotate immediately to the entered start position. This may occur when a command is in progress or when the carousel has been rotated several positions either manually or with the 4551 keypad. The display will be updated when the 4551 returns to its home position or when the command in progress is complete.



Replicate Menu

Programming Replicates

For each 5-mL sample, a replicate quantity, up to 3, can be selected. To program replicates for a sample sequence:

1. From the main menu, press the 2nd function key and the [SPL] key to reach the REPLICATE (REP) menu.
2. Using the number keys, enter the desired number of replicates, up to three (depending on loop fill time optimization), then press [ENTER].

Note: There is insufficient sample in a 40-mL vial for more than three replicates, as more than 5 mL of sample are used to fill the sample loop. Only one 25-mL sample may be extracted from a 40-mL vial.

3. Press [CLEAR] to return to the main menu.

Saving the Method File

1. Save this programmed file if desired (refer to the “File Management Key” in Chapter 4, “Operation,” of the 4560 Operator’s Manual).
2. Press [CLEAR] to return to the main menu.

Operation of the Model 4551 with the Model 4560

Pre-Run Checks

1. Check the water level of the reagent water bottle to verify that it is sufficient to run the programmed sequence. Refill if necessary.
2. Verify that the WASH/WASTE stations are loaded in the carousel.
3. Verify that the waste bottle is empty, or sufficiently empty so that it doesn't overflow during the programmed sequence.
4. Verify that the SIM/Spiker option is programmed and loaded (see Chapter 5, “SIM/Spiker Option”).

To Start a Run

1. Press the [START] key. The Model 4551 will automatically run the sample pump to evacuate the transfer lines until they are residue-free. The 4551 will then begin the programmed analyses.



To Stop a Run

- Stop an analysis by pressing [HOLD], 2nd function key, and [ON].

Sample Checks

Watch the first sample transfer to verify proper operation of the Model 4551.

Note: To prevent drainage backup, if the Model 4551 is on, the Model 4560 will *always* drain, even if the drain is disabled.

- Verify that the sample loop ports do not leak during the analysis. If a leak is detected, stop the run and tighten the port connections.

Note: Leak-checks for the Model 4551 are done visually.

To Run Priority Samples

If a sequence is programmed and running, and a separate sample needs to be tested immediately, it can be run as a priority sample. The Model 4551 Vial Autosampler will finish the current sample analysis, insert and run the priority sample, then continue with the programmed sequence.

1. Press the gold [PRIORITY] key on the 4551 keypad. As soon as the needle can be raised during the current analysis, the carousel will automatically rotate so that the priority sample position (pos. 0, for programming purposes) is accessible for vial insertion.
2. Remove the carousel cover.
3. Insert the priority sample vial into position.
4. Replace the carousel cover.
5. Press the gold [PRIORITY] key again. The Model 4551 will finish the current run, run the priority sample, then continue with the programmed sequence.

To Perform a Manual Wash

A manual wash is recommended before starting a new sample sequence to ensure cleanliness. A manual wash is also recommended as a cleanup procedure if contamination is suspected.

1. Press the 2nd function key (the gold key) and the [TIME] key to configure.
2. Select OPTIONS from the display menu by pressing either arrow key, then press [ENTER].
3. Select 4551 from the display menu by pressing either arrow key, then press [ENTER].



4. Press [1] to configure the option. The WASH menu will display.
5. While in the WASH menu, press [START], then verify the manual wash by pressing [ENTER].



Chapter 5

SIM/Spiker Option

The Model 4551 SIM/Spiker option (SIM) allows for a 10 μ L standard or surrogate addition to the sample during the sample transfer to the sparge vessel. This option contains up to two separate standard syringes that can add internal standard (ISTD) or surrogate/matrix spikes at programmable sampling intervals.

SIM/Spiker Option Features

- Automated internal standard (ISTD) or surrogate/matrix spike injections at definable intervals.
- The ISTD or surrogate is swept into the sparge vessel by the sample itself.
- The SIM module easily snaps onto the Model 4551 chassis.
- Auto-loading syringes minimize analyst contact with SIM syringes.
- Excess standard is automatically drained to an available waste bottle or, alternately, to a secondary collection syringe.
- The Model 4560 Sample Concentrator can control up to two SIM units for each Model 4551 Vial Autosampler.
- The second SIM can be added easily and affordably.

Installing the SIM/Spiker Option

The following instructions are for installing either two SIMs or a single SIM. If installing two SIMs (SIM A and SIM B), both will already be positioned in the SIM housing. If installing a single SIM (SIM A), it will be positioned in Slot A of the SIM housing and Slot B will be covered. A second SIM (SIM B) may be installed at a later date by following the instructions of “Installing SIM B” later in this chapter.

1. Verify that all power to the Model 4560 and Model 4551 is off and that both instruments are unplugged.
2. Gently slide off (by sliding forward and upward) the existing side cover of the Model 4551 and replace it with the new side cover (Part #257105) provided with the SIM/Spiker option (Part #242008).

CAUTION:
When installing the SIM/Spiker option, verify that both the 4560 and the 4551 are unplugged, to prevent electrical malfunction or damage.



CAUTION:
Verify that the
Model 4551
power is off when
connecting
cabling to
prevent electrical
malfunction or
damage.

3. Line up the three holes on the bottom panel of the SIM housing with the three metal nibs protruding from the top of the side cover and snap the SIM housing into position.
4. Remove the sparge mount cover from the Model 4560 by gently pulling it forward.
5. Remove the existing nickel sample transfer line by unscrewing the connecting nut from the 4 o'clock position of the Model 4551 6-port loop valve and disconnecting the other end of the line from the sample valve assembly of the Model 4560.

Install the new transfer line(s) (depending on whether you are installing 1 or 2 SIMs) by finger-tightening and connecting the proper ends to the outside SIM ports:

1. If installing SIM A and SIM B, connect transfer lines following the diagram and part numbers shown in Figure 5.1.
2. If installing only SIM A, connect transfer lines following the diagram and part numbers shown in Figure 5.2.
3. Interface the SIM/Spiker option to the 4551 by plugging one end of the provided ribbon cable (Part #257683) into the Model 4551 back panel and the other end into the SIM/Spiker back panel (see Figure 5.3).
4. Turn the Model 4551 power on.

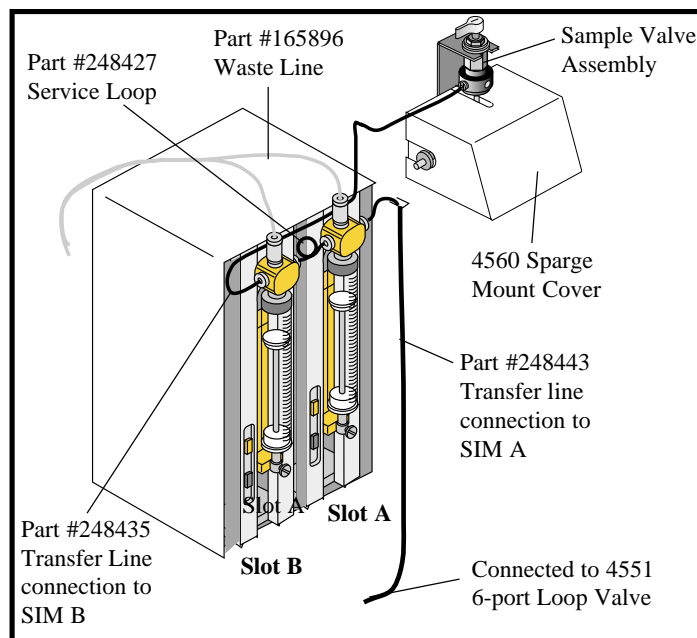

Figure 5.1. SIM/Spiker Connections

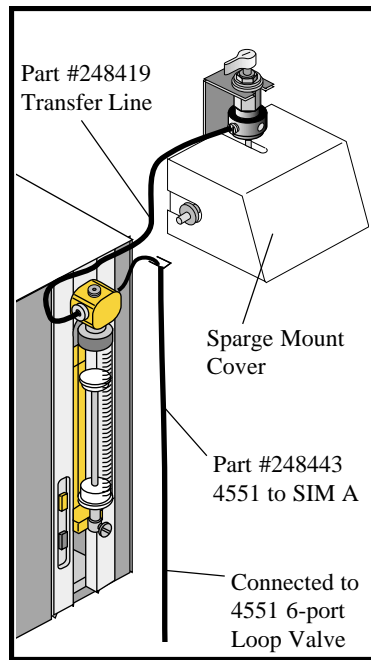

Figure 5.2. Single SIM (SIM A) Connections

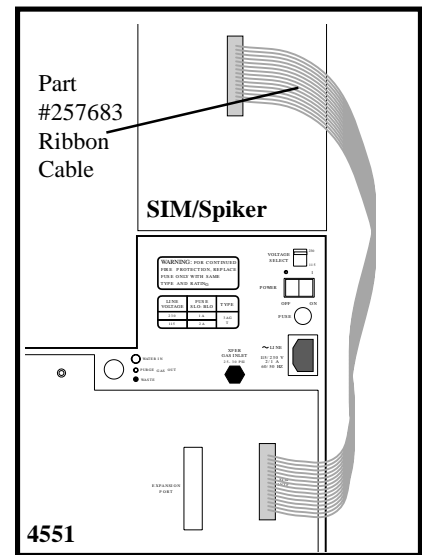

Figure 5.3. SIM Interface

Installing SIM B at a Later Date

If SIM B (Part #248138) is later added to an existing SIM A, the cover plate over Slot B must be removed and the SIM B syringe drive inserted into the vacant slot. To remove the cover plate from Slot B, the SIM A syringe drive must be removed to access the Allen screws that hold the cover plate.

CAUTION:
Verify that the 4551 power is off when installing SIM B, to prevent electrical malfunction or damage.

1. Turn off the Model 4551 and Model 4560 power and unplug the ribbon cable connecting the SIM/Spiker option to the Model 4551.
2. Disconnect all plumbing from SIM A (see Figure 5.2).
3. Remove the SIM housing from the Model 4551 side cover and position the housing in a suitable work area.
4. Remove the Phillips screw holding SIM A in the housing. The screw is located on the bottom of the SIM housing.
5. Slide the SIM A syringe drive out of the SIM housing by pulling the handle outward.
6. Remove the cover plate from Slot B by removing the two 4/40" Allen screws visible from the left side of Slot A after the SIM A syringe drive is removed.
7. Slide both SIM A and SIM B syringe drives into the SIM housing.



Note: A pin connection is made when the SIM is inserted into the housing. If too much resistance is apparent, do not attempt to force the SIM into the slot; instead, remove and realign the syringe drive.

8. Attach each SIM syringe drive to the housing with the Phillips screws, one underneath each SIM syringe drive on the bottom of the housing.
9. Reattach the SIM housing to the Model 4551.
10. Connect the transfer lines following the diagram and part numbers in Figure 5.2. Reconnect the ribbon cable.

Programming the SIM/Spiker Option ██████████

Program the SIM/Spiker option from the Model 4560 Sample Concentrator keypad:

1. Press the 2nd function key (the gold key) and the [TIME] key to configure. Choose OPTIONS from the display menu by pressing either arrow key, then press [ENTER].
2. Select 4551 from the display menu by pressing either arrow key, then press [ENTER].
3. Press the [1] key on the number pad to configure, then press [ENTER] twice to reach the SIM A display.
4. Press the arrow key labelled ON to enable the SIM, then use the number keys on the keypad to program the injection interval (e.g., an interval of 2 will add a spike after every two samples). Press [ENTER] to program SIM B (if applicable), or press [CLEAR] repeatedly to reach the main menu.
5. If SIM B is installed, the SIM B display will appear. Press the arrow key labelled ON to enable SIM B, then use the number keys to program the injection interval. Press [CLEAR] repeatedly to reach the main menu.

The SIM/Spiker will automatically add standard or surrogate to the Model 4551 analysis as programmed through the 4560 Sample Concentrator.



Loading the SIM/Spiker Option

Standard can be loaded into the SIM/Spiker by syringe transfer or manually.

Syringe Transfer Loading (see Figure 5.4)

To load the standard by syringe transfer, the SIM syringe remains in position on the SIM while a separate syringe screws onto the top of the SIM valve and transfers standard between the two syringes. This method of sample loading is simpler than manual loading.

1. Fill a 10–25 mL syringe (not included) with the desired standard and evacuate all headspace by depressing the plunger and/or tapping the syringe.
 2. Press the up arrow key next to the SIM syringe until the plunger moves to the top of the syringe.
 3. Disconnect the waste line from the Luer-lock fitting (on the top of the SIM Valve) by gently turning the adaptor fitting and removing the entire waste line assembly.
 4. Screw the filled syringe onto the Luer-lock fitting from which the waste line assembly was just removed.
 5. Press the down arrow key on the SIM to transfer the standard from the upper syringe to the SIM syringe (the upper syringe may need to be depressed to aid the transfer).
- Note:** If the Model 4551 status LED is blinking, this indicates that a command is being executed and the SIM syringe may not respond until the command is complete.
6. When the standard has been completely transferred, remove the upper syringe and reconnect the waste line.
 7. Pressing the up/down arrow keys, move the SIM syringe up until all headspace is removed from the standard.

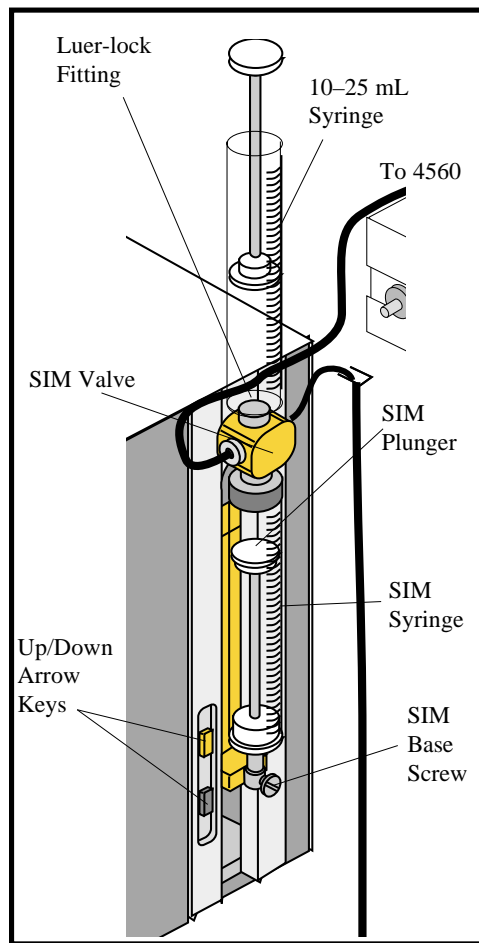

Figure 5.4. Syringe Transfer Loading



Manual Sample Loading and SIM Syringe Cleaning

Loading the standard manually involves removing the syringe from the SIM, loading the standard, then replacing the SIM syringe. This is also the procedure for cleaning the SIM syringe, when necessary. See Figures 5.1 and 5.4 for SIM part references.

1. Press the down arrow key to the left of the desired syringe to fully depress the SIM syringe plunger.

Note: If the syringe does not respond, wait until the Model 4551 executes the current command.

2. With a flathead screwdriver, loosen and remove the base screw that connects the SIM syringe plunger to the SIM body at the base of the SIM syringe (see Figure 5.4).
3. Finger-loosen the knurled fitting holding the syringe to the SIM valve (the gold valve at the top) and remove the SIM syringe.
4. Fill the syringe with the standard and evacuate any headspace by depressing the plunger and/or tapping the syringe.
5. Screw the filled syringe back into place by finger-tightening the knurled fitting connected to the SIM valve.
6. Pressing the up/down arrow keys to move the plunger up and down, line up the screw hole at the bottom of the SIM syringe plunger with the hole in the SIM body.
7. Replace the base screw removed from the base of the SIM syringe using a flathead screwdriver.



Chapter 6

Maintenance

The Model 4551 Vial Autosampler requires very little maintenance other than cleaning and basic part replacements. This chapter describes cleaning, replacement, and general maintenance procedures for the sample loop, needle drive assembly, and glassware of the Model 4551.

Cleaning Procedures

Cleaning the Sample Loop

The sample loop is cleaned during each programmed WASH sequence. It is not necessary to remove and manually clean the sample loop unless contamination is suspected. To manually clean the sample loop:

1. Finger-loosen the loop fittings on each side of the 6-port loop valve and remove the sample loop.
2. Remove the Viton® o-rings (Part #257378) on each sample loop end (see Figure 6.1). These o-rings can be removed with any small tool.
3. Flush the sample loop thoroughly with DI water.
4. Bake the sample loop in the GC at 180°C for 2–3 hours.
5. Replace the o-rings. Usually the old o-rings can be reused; however, after several cleanings, they may need to be replaced.
6. Gently pull the ends of the sample loop apart and place each end into the corresponding 6-port loop valve position, as before.
7. Finger-tighten the screws until snug (about 1 1/2–2 turns).

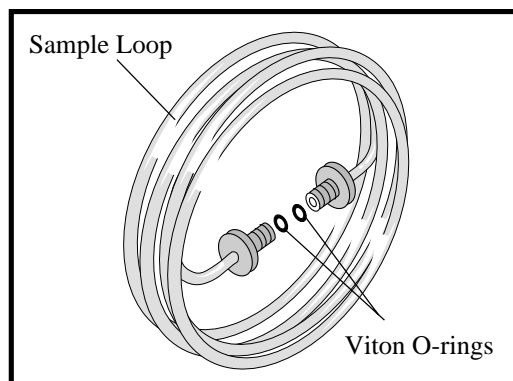

Figure 6.1. 5-mL Sample Loop

CAUTION:
Over-tightening the loop fittings may cause irreparable damage to the valve body. Finger-tightening is sufficient to form a leak-free seal.

Note: After replacement, observe one full sample transfer to verify that the connection is leak-free.



Cleaning the Reagent Water Bottle

If the reagent water bottle becomes contaminated, it is necessary to clean it manually. To clean the bottle:

1. Rinse the bottle thoroughly with DI water.
2. Bake the bottle in the GC at 180°–200°C for 2–3 hours.

Cleaning Glassware

Clean glassware as needed following the guidelines outlined in the United States Environmental Protection Agency's Test Methods for Evaluating Solid Waste (November 1986), Volume 1B, section 4.1.4.

Replacement Procedures

Changing the Sample Loop

The sample loop should not be replaced unless it is damaged or if it is being replaced with a different size sample loop (e.g., 5-mL to 25-mL). To change the sample loop, perform the following steps:

1. Finger-loosen the screws on each side of the 6-port loop valve and remove the sample loop.
2. Pull the ends of the new sample loop apart and place each end into the corresponding 6-port loop valve position, as before (be careful not to cross-thread the loop fitting nut).
3. Finger-tighten the screws until snug (about 1 1/2–2 turns).

Note: After replacement, observe one full sample transfer to verify a leak-free connection.

Changing the Needle Transfer Line (see Figure 6.2)

Replace the needle transfer line (Part #256529) only if it becomes damaged or contaminated.

1. Loosen and remove the tube nut (Part #248757) from the sample filter using a 1/4" wrench. Use the backup wrench on the sample filter to avoid loosening the sample filter.
2. Loosen and remove the 1/16" SS fitting (Part #256966) from the other end of the needle transfer line. The needle drive cover may need to be removed to access this fitting.

CAUTION:
Over-tightening the loop fittings may cause irreparable damage to the valve body. Finger-tightening is sufficient to form a leak-free seal.



3. Install the new needle transfer line (Part #256529) by performing steps 1 and 2 in reverse order.

Changing the Sleeve Transfer Line (see Figure 6.2)

Replace the sleeve transfer line (Part #257246) only if it becomes damaged or contaminated.

1. Loosen and remove the 1/16" SS nut (Part #223057) from the needle manifold. Place a backup wrench on the needle manifold to reduce stress points.
2. Loosen and remove the 1/16" SS fitting (Part #256966) at the other end of the sleeve transfer line. The needle drive cover may need to be removed to access these fittings.
3. Install the new sleeve transfer line (Part #257246) by performing the above steps in reverse order.

Changing the Sample Filter (see Figure 6.2)

Replace the sample filter in the needle drive assembly if it becomes clogged.

1. Loosen and remove the tube nut (Part #248757) located above the sample filter (Part #248047) using a 1/4" wrench. Use a backup wrench on the sample filter to avoid loosening the sample filter.
2. Remove the sample filter (Part #248047) using a 1/4" wrench.
3. Install the new sample filter, then perform the above steps in reverse order.

Changing the Septum-Piercing Needle (see Figure 6.2)

Replace the Septum-Piercing needle (Part #256610) only if it becomes clogged, damaged, or too dull to perform analyses.

1. Remove the needle drive cover.
2. Using the 1/4" wrench, remove the tube nut (Part #248757) from the sample filter.
3. Using the 1/4" wrench, remove the sample filter (Part #248047).
4. Loosen the 1/16" union (Part #253559) using the 1/4" nut driver (Part #223917) included in the 4551 Start-up Kit.
5. Slide the needle out through the top of the needle manifold.
6. Slide the replacement needle, with pre-attached ferrule, into the needle manifold.



7. Tighten the 1/16" union (Part #253559) with the 1/4" nut driver (Part #223917) and reattach the needle transfer line (Part #256529).

Changing the Needle Sleeve (see Figure 6.2)

Replace the needle sleeve (Part #256628) only if it becomes clogged or damaged.

1. Remove the needle drive cover.
2. Loosen the fittings above the septum-piercing needle (as described in the previous section, "Changing the Septum-Piercing needle") and partially slide the needle out of the needle manifold.
3. Loosen and remove the 1/16" SS nut (Part #223057) located below the needle manifold.
4. Slide the needle sleeve out of the manifold and off the needle.
5. Slide the new needle sleeve over the needle until the top of the sleeve fits into the needle manifold.
6. Tighten the existing 1/16" SS nut (Part #223057) to seal the needle sleeve, ensuring that the septum-piercing needle slides freely through the sleeve.

Note: Do not overtighten the tube nut, or the needle sleeve may collapse around the needle.

7. Replace the septum-piercing needle and re-tighten all the needle fittings.

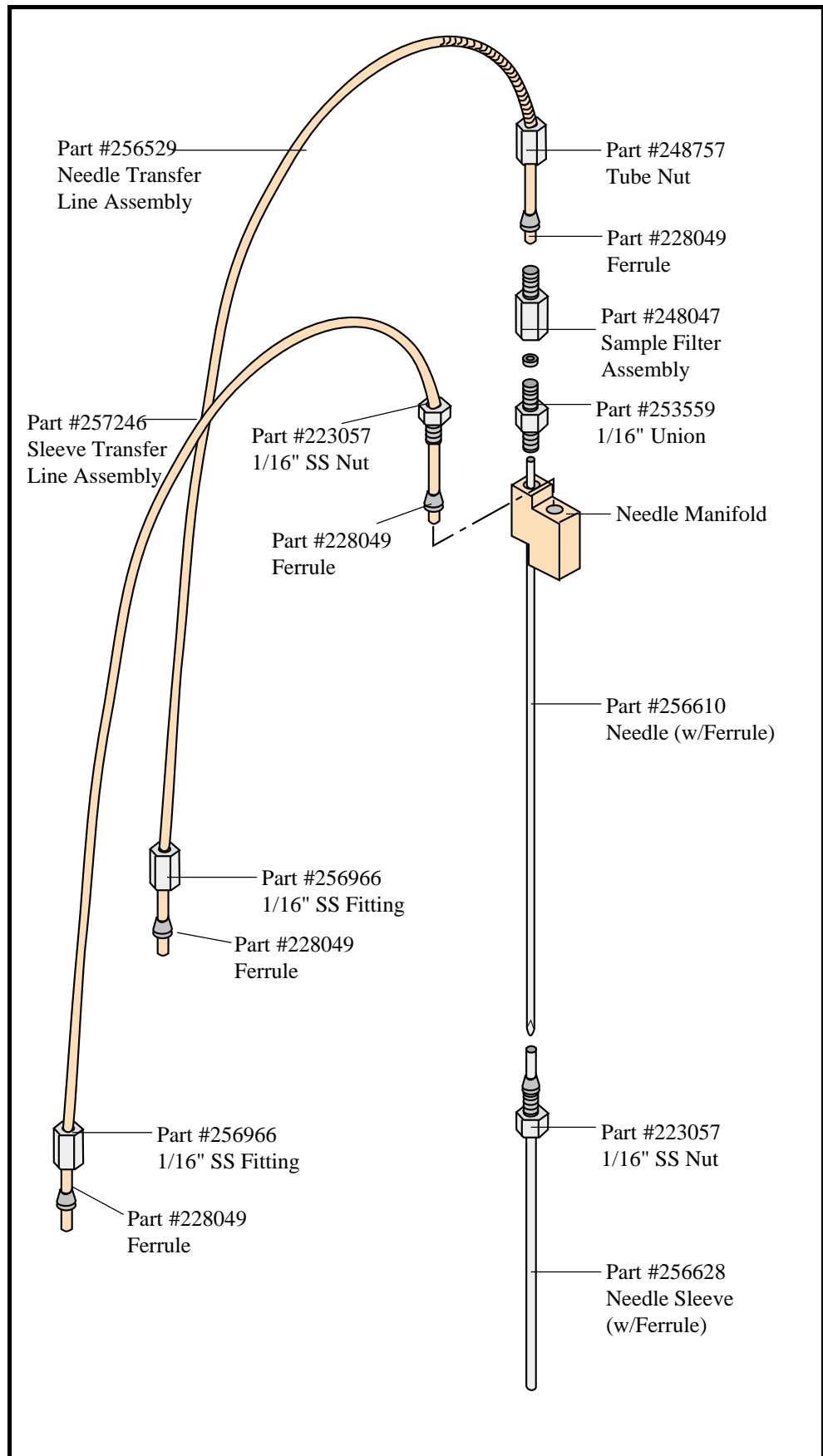

Figure 6.2. Needle Assembly



Notes



Chapter 7

Troubleshooting

This chapter lists problems that might occur during normal operation of the Model 4551 Vial Autosampler along with possible solutions. Any maintenance that involves the interior components of the 4551 should be performed by OI Analytical trained technical support personnel only. If a problem still exists after reviewing the following chart, or if it is not addressed, contact OI Analytical's Customer Service Department for assistance at 1-800-336-1911.

CAUTION: TO REDUCE THE RISK OF ELECTRICAL SHOCK, DO NOT REMOVE THE 4551 COVER (OR BACK). NO USER-SERVICEABLE PARTS ARE INSIDE. REFER SERVICING TO QUALIFIED OI ANALYTICAL CUSTOMER SERVICE PERSONNEL.

Model 4551 Troubleshooting Chart

Symptom	Probable Cause	Corrective Action
Unit will not turn on	Power cord not plugged in	Plug in power cord
	Blown fuse	If back panel fuse, replace the fuse. If any other fuse, contact the Customer Service Department.
	Faulty power supply	Contact the Customer Service Department
	DC cable unplugged on 4551 main board	Contact the Customer Service Department
Communication lost between 4551 and Sample Concentrator (locked-up or not executing commands)	If front LED is flashing, 4551 is executing command	Wait until current command execution is complete
	O•I•NET BNC cable is not connected	Connect BNC cable
	Units are out of synchronization	Clear the Sample Concentrator by returning to STANDBY
4551 not extracting sample from VOA vial or wash station	If the sample pump is not running: loop fill time is "0"	Extend loop fill time
	Leak	Leak-check associated fittings
	Clogged needle	Clean the needle
	Clogged filter	Clean, remove, or replace the filter

(Continued on next page)



Symptom	Probable Cause	Corrective Action
4551 not extracting sample from VOA vial or wash station	6-port valve stuck in mid-position Needle transfer and sleeve transfer lines reversed	Cycle 4551 power to realign valve Switch lines
4551 extracts wash water or blanks, but not from VOA vial	4551 has been programmed to perform blanks only	Check programming
Sample is pumped from vial or wash station, but not transferred to sparger	Transfer time is "0" Transfer valve is unplugged	Extend transfer time Contact the Customer Service Department
Slow sample transfer to sparger	Needle opening obstructed Leak Insufficient gas flow	Raise needle slightly off 4560 frit Leak-check all connections Verify 25–30 psi transfer gas pressure
4551 not performing washes	Washes turned off	Check programming
4551 needle assembly not lowering to pierce vial	Carrousel cover removed, interlock switch interrupted Wrong vial type No vial detected	Replace carrousel cover Use only standard 40 mL VOA vials Use thicker septa for vials (do not re-use septa)
Carrousel advances to unwanted position	Wrong "start" sample position programmed	Check programming
Needle not piercing center of septum	Bent needle Carrousel needs calibration	Replace needle Perform carrousel home calibration and cycle power; if 4551 doesn't remember new home position, suspect weak or dead 3.6 V battery
Wash vessel completely emptied during washes or blanks	Wash station calibration too low Loop fill time excessive	Recalibrate wash station with higher water level Reduce loop fill time
Needle remains in wash or waste station without raising	Carrousel cover is off	Replace carrousel cover



Symptom	Probable Cause	Corrective Action
Reagent (blank) water drips from spout	Low gas pressure Siphoning effect, bottle is higher than the 4551	Adjust incoming gas pressure Position bottle lower than 4551
Carrousel wobbles	Carrousel not seated properly	Manually rotate carrousel until it drops into position with the carrousel alignment notch
One of the following zones shows no sign of power (movement): • Carrousel • Needle Drive • Sample Valve Actuator • Sample Pump	Cable may be unplugged, pinched, or plugged into the wrong connector on the 4551 main board	Contact the Customer Service Department
Wash station overfills	Calibration level too high (too close to top of wash vessel)	Recalibrate wash station level

SIM/Spiker Option Troubleshooting Chart ■

Symptom	Probable Cause	Corrective Action
SIM (A or B) not injecting at selected intervals	SIM A and B programming reversed	Check programming
Manual syringe plunger advance not responding	If LED is flashing on 4551 keypad: If SIM LED flashes when up/down arrow keys are pressed:	Wait, a command is being executed Check cable and cycle power; if unresponsive, contact the Customer Service Department
No response from SIM (LEDs on front panel don't illuminate when buttons are pressed)	Cable unplugged	Plug in cable; if unresponsive, contact the Customer Service Department



Notes



Chapter 8

Replacement Parts

This chapter lists the order numbers for replacement parts and support items for the Model 4551 and its associated options. Replacement parts considered as expendable (XPND) are marked with an asterisk. (Expendable components should be replaced regularly or are easily broken or deformed.) A supply of XPND parts should be kept on hand. Units of measure (U/M) are also given. If a part is shown in a drawing, the figure number is listed under “Fig.”

Model 4551 Vial Autosampler Parts

<u>Part Name</u>	<u>Part #</u>	<u>U/M</u>	<u>XPND</u>	<u>Fig.</u>
Boards				
AC Power	235861	ea		
CPU	257139	ea		
Keyboard	254318	ea		
Main	234575	ea		
Power Supply	231712	ea		
Stepper Motor Drive	231985	ea		
Cables				
BNC to BNC - 3 ft.	235515	ea		3.1
Power Cord	116038	ea		3.1
Fittings and Ferrules				
Assembly - Sample Filter	248047	ea		8.1
Ferrule - 1/16 PEEK Ring	257675	ea		
Ferrule - Br 1/16 Tube Reverse	228049	ea	*	8.1
Fitting - Barb 1/4-28 x 1/8	257493	ea		
Fitting - Nut SS 1/16 Female	256966	ea		8.1
Fitng - Nut SS 1/16 Male DSF	223057	ea		8.1
Fitting - Nut SS 1/16 Spring	248757	ea		8.1
Fitting - Plug 10-32 O-Ring	177502	ea		
Fitting - TEE Polypropylene 1/8 x 1/8 x 3/32	257485	ea	*	
Fitting - Union SS 1/16 Male DSF	253559	ea		8.1
O-Ring (Viton) .042 x .042	236604	ea	*	
O-Ring (Viton) .118 x .039	257378	ea	*	8.2
O-Ring (Viton) .156	236620	ea	*	
O-Ring (Viton) .250 x .070	236612	ea	*	
Restrictor-Cylinder 25 mL @ 30 psi	233403	ea		
Restrictor-Cylinder 100 mL @ 30 psi	236562	ea		
Restrictor-Cylinder 250 mL @ 30 psi	248179	ea		



<u>Part Name</u>	<u>Part #</u>	<u>U/M</u>	<u>XPND</u>	<u>Fig.</u>
Glassware				
Assembly - Reagent Water Bottle	248915	ea		
Bottle - 1 Gallon Amber	257360	ea		
Cap - 40 mL VOA Vial	174532	pk	*	
Septum - 40 mL VOA Vial	173211	pk	*	
Vial - 40 mL VOA	173196	box	*	
Vial - Wash/Waste Station	232801	ea	*	
Tubing and Tube Assemblies				
Tube Assembly - Manifold to Needle Sleeve	257386	ea		
Tube Assembly - PEEK Sample Transfer	256529	ea	*	8.1
Tube Assembly - PEEK Transfer Gas	257246	ea	*	8.1
Tube Assembly - Transfer in to Manifold	257410	ea		
Tube Assembly - Transfer Line 4551 to 4560	235879	ea		
Tube Assembly - Valve to Needle	257394	ea		
Tube - Norprene® 1/8 x 3/8	234914	ea	*	
Tube - Valve to Manifold	257402	ft		
Tubing - Copper 1/8 x .070	111427	ft		
Tubing - Silicon 1/8 x 1/16	179812	ft		
Tubing - Teflon 1/16 x .020 ID	165896	ft	*	
Tubing - Teflon 1/8 x .063 ID	147901	ft	*	
Tubing - Tygon® 3/16 x 1/16 ID	174003	ft	*	
Tubing - Tygon 1/4 x 1/8 ID Clear	257469	in	*	
Tubing - Urethane 1/8 x 1/16 ID Brown	257550	in	*	
Tubing - Viton 1/4 x 1/8 ID Black	257477	in	*	
Valves and Valve Assemblies				
Valve Assembly - 2-Way Pinch	233478	ea		
Valve - Brass/Nickel 3-Way Manifold	179325	ea		
Valve - KEL-F 4-Port Sample	237180	ea		
Valve - KEL-F 6-Port Sample	234617	ea		
Valve - Polypropylene Check 1/8 x 1/16	257527	ea		
Other 4551 Parts				
4560 Door for 4551	257428	ea		3.3
Assembly - Sample Tray 4551 White	234815	ea		
Battery - 3.6V Back-Up	211953	ea	*	
Cover - Loop	257451	ea		2.2
Cover - Carrousel	257436	ea		2.2
Firmware - 4551 (Latest Revision)	257147	ea		
Fuse - 2 AMP 250V	211441	ea	*	
Fuse - 3.15 AMP 5 mm x 20 mm	257329	ea	*	
Kit - Start-up	235689	ea		
Manual - Operator's/4551	235895	ea		
Needle - Septum Piercing	256610	ea	*	8.1
Needle - Xfer Gas Sleeve	256628	ea	*	8.1
Pump - Peristaltic Head	256644	ea		
Pump - Reagent Water 24V	233486	ea		
Pump Assembly - Peristaltic	256941	ea		



<u>Part Name</u>	<u>Part #</u>	<u>U/M</u>	<u>XPND</u>	<u>Fig.</u>
Sample Loop - 5 mL	235911	ea		8.2
Sample Loop - 25 mL	235903	ea		
Transducer - Pressure 0-15 psi	234591	ea		

SIM/Spiker Option Parts

Board - Control SIM/Spiker	241950	ea		
Cable - Interface 4551/SIM	257683	ea		5.3
Ferrule - Teflon 1/16 Tube	272443	pk	*	8.4
Fitting - Adaptor Brass/Nickel	248450	ea		8.4
Fitting - Adaptor Luer-lock 1/4 x 28	169468	ea	*	8.4
Fitting - Nut SS 1/16 Male DSF Knurled	217240	ea		8.4
O-Ring (Viton) .042 x .050	199869	ea	*	
Syringe - 10 mL Sample w/Luer	242065	ea		8.3
Tube Assembly - 4551 to SIM A	248443	ea		8.3, 8.4
Tube Assembly - SIM A to 4560	248419	ea		8.3
Tube Assembly - SIM A to SIM B	248427	ea		8.4
Tube Assembly - SIM B to 4560	248435	ea		8.4
Tube Assembly - SIM Waste	248401	ea		8.4
Tubing - Teflon 1/16 x .020 ID	165896	ft	*	8.4

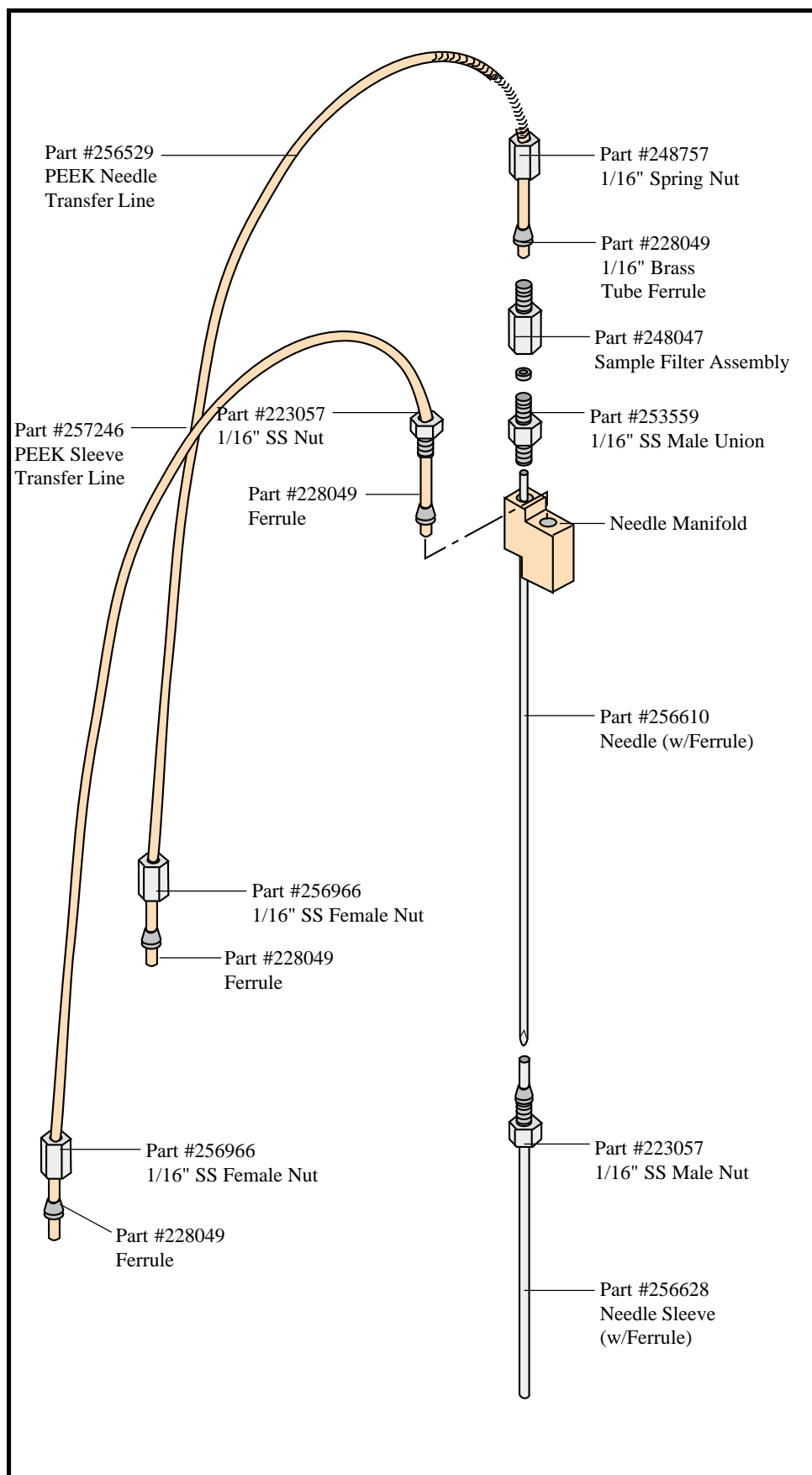

Figure 8.1. Needle Drive Assembly

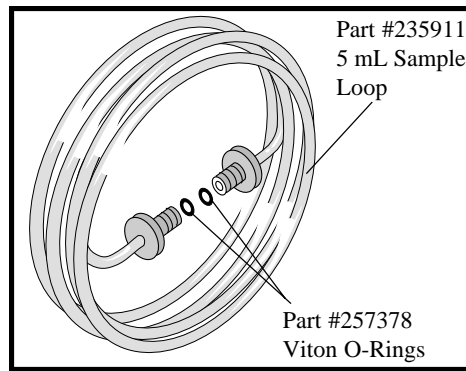

Figure 8.2. 5 mL Sample Loop

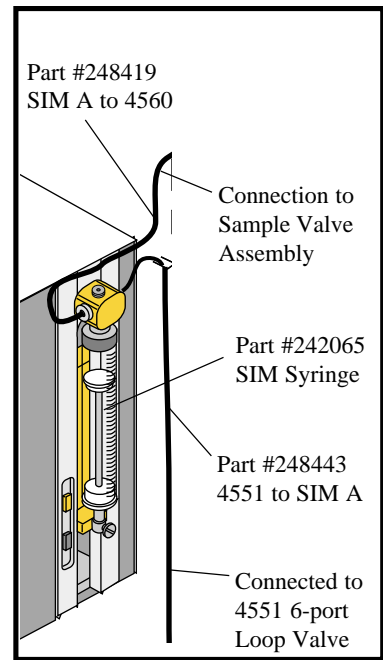

Figure 8.3. Single SIM (SIM A) Connections

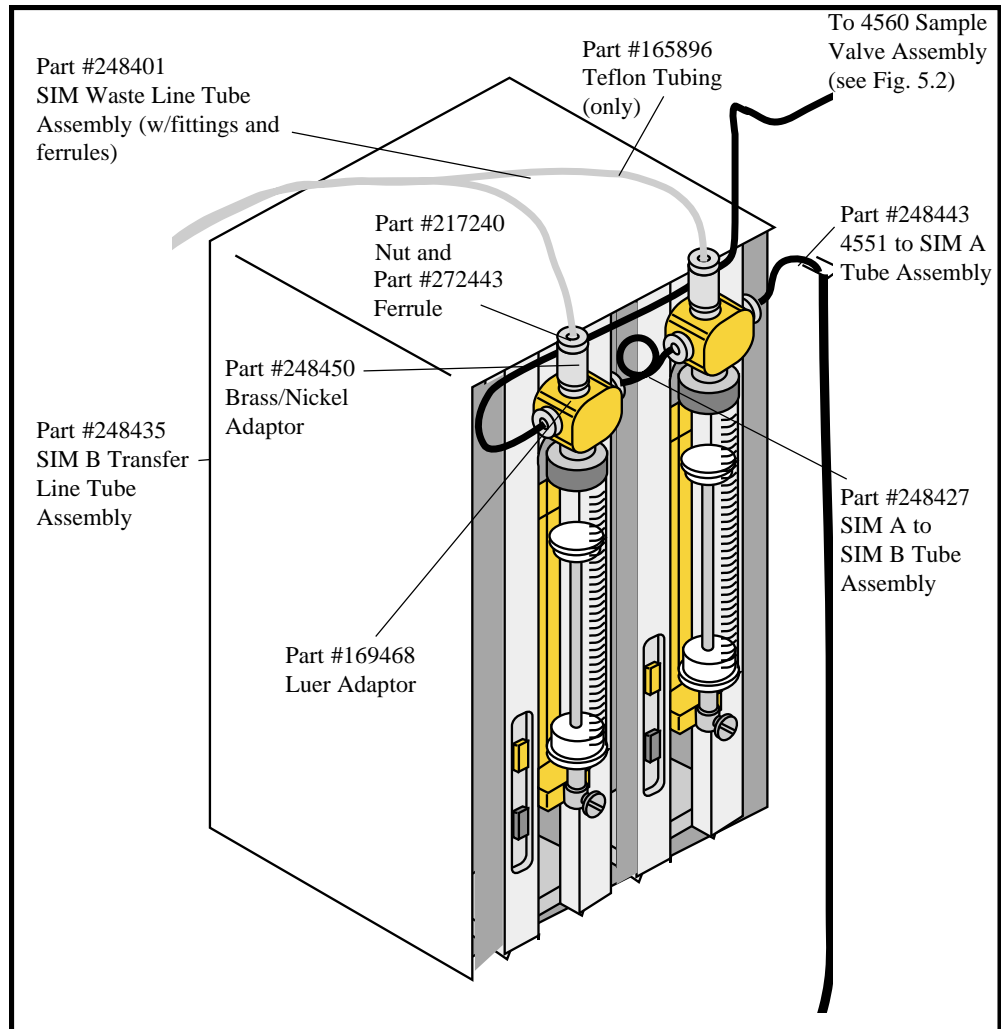

Figure 8.4. SIM Connections with Two SIMS, SIM A and SIM B



Notes





Appendix

4560 Keystrokes, Visual

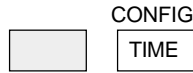

The following is a visual guide for programming the 4560 to run a sequence with the 4551. See Chapter 4, “Operation,” for a written explanation.

- To start the 4551 and reach the configuration menus:



Choose OPTIONS using   , then



Choose 4551 using   , then







to reach the Wash menu.

Configuration Menu

- Wash Menu**—Programs the number of washes/sample.



In the Wash menu:



Enter values using   and the number keypad,  to confirm entry, then  to move to the next menu.

- Blanks Menu**—Programs the number of blanks to run after a programmed sample interval.

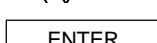

In the Blanks menu:

Enter values using   and the number keypad,  to confirm entry, then  to move to the next menu.

- SIM A/SIM B Menus** (if installed)—Program the SIM intervals.

In the SIM A menu:





to turn the SIM on, then enter the interval with the number keypad,  to confirm entry, then  to move to the next menu.





Perform the same keystrokes to program SIM B, if applicable.

- **Sample Volume Menu**—Programs the appropriate sample volume depending on the sample loop size.

In the Sample Volume menu:



Choose 5 mL or 25 mL using   then either  to move to the next menu,

OR
if setting custom loop fill and sample transfer times, press  from the Sample Volume menu before pressing 

Custom Loop Fill/Sample Transfer Times



- **Loop Fill/Sample Transfer Menu**—Programs the loop fill/sample transfer times.



After pressing  from the Sample Volume menu:

Choose loop fill or sample transfer times using  , enter values using the number keypad, then  to return to the Sample Volume menu.

Press  from the Sample Volume menu to move to the next menu.

- **Needle Depth Menu**—Programs the depth the needle lowers into the vial.

From the Needle Depth Menu, enter the depth percentage using the number keypad (before setting depth, use   to demonstrate needle depths in intervals of 5%).





Then press  to confirm entry and  repeatedly until reaching the main menu.

Sample Menu

- **Start/End Menu**—Programs the carousel start and end sample positions.

From the main menu:



Choose Start and End sample positions using   and enter values using the number keypad,  to confirm entry, then  to return to the main menu.





Replicate Menu

- **Replicate Menu**—Programs the number of samples to be extracted from each vial.

From the main menu:



Enter number of replicates using the number keypad, then  to confirm entry.

Press  repeatedly to return to the main menu.

Starting, Stopping, Pausing a Sequence

- To **start** a sequence,



- To **stop** a sequence,



- To **pause** a sequence,

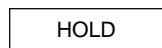



Configuration Menu

On the facing page is the Configuration Menu of the Model 4560 Sample Concentrator when used with the Model 4551 Vial Multisampler. A written explanation for programming the 4560 is in Chapter 4, “Operation,” and the visual keystrokes for programming are earlier in the Appendix.

(Only one sampler allowed ON per method.)

4551 CONFIGURATION MENUS

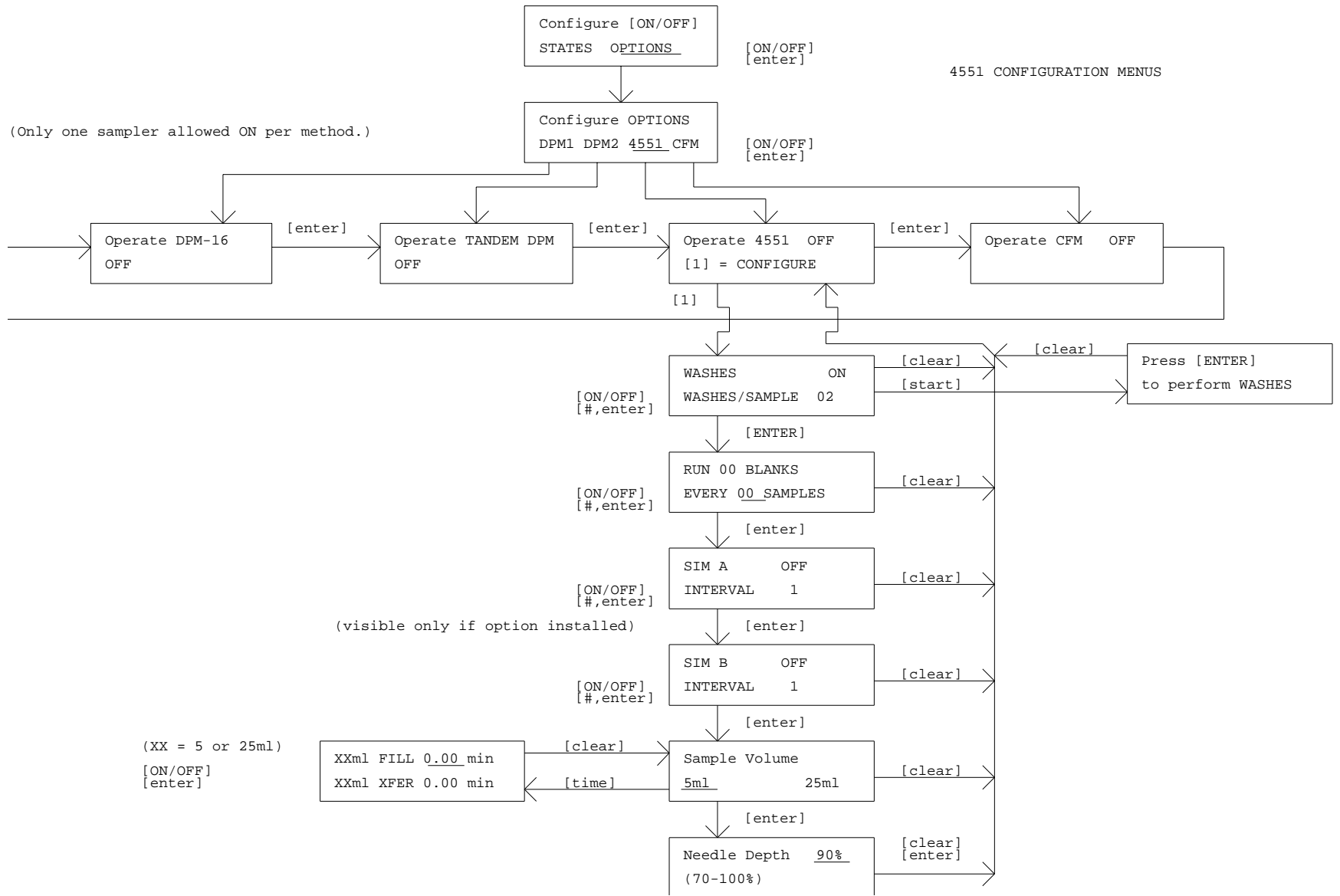



Sample/Replicate Menu

Below are the Sample and Replicate Menus of the Model 4560 Sample Concentrator when used with the Model 4551 Vial Multisampler. A written explanation for programming the 4560 is in Chapter 4, "Operation," and the visual keystrokes for programming are earlier in the Appendix.

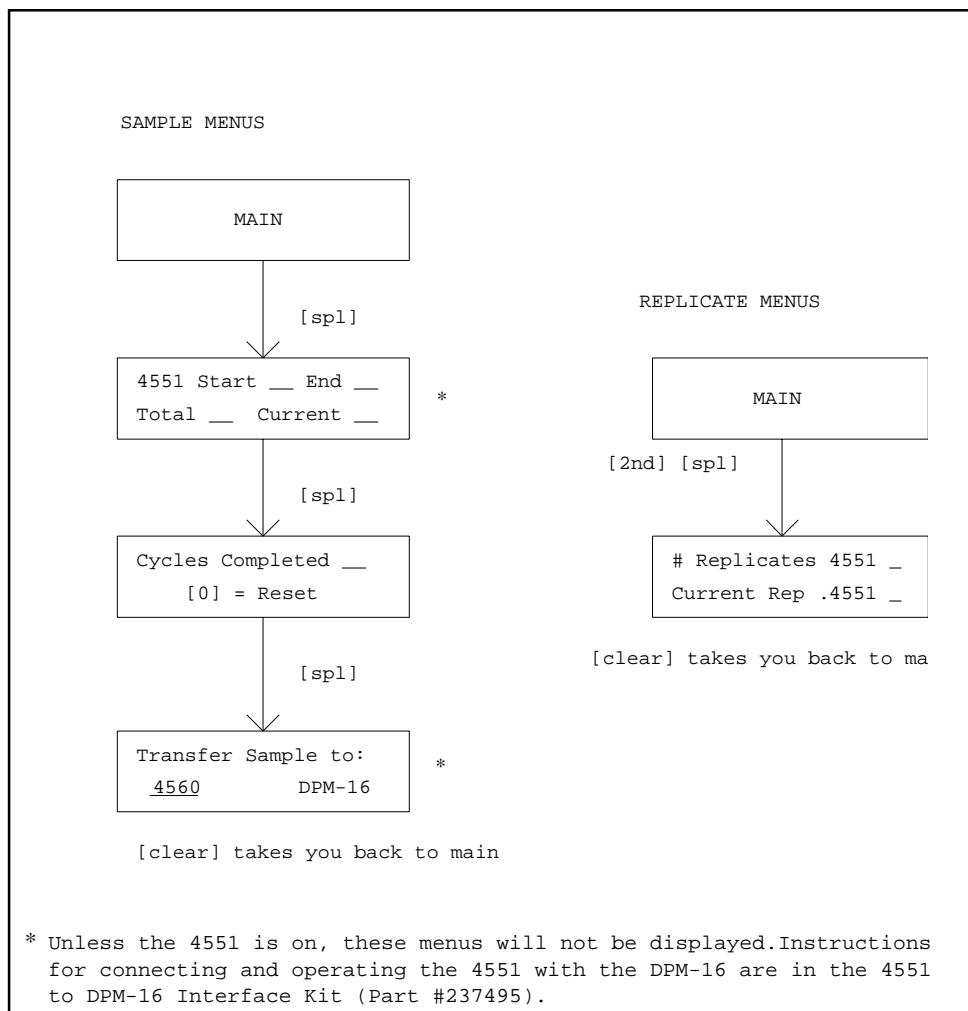

Plumbing Schematic

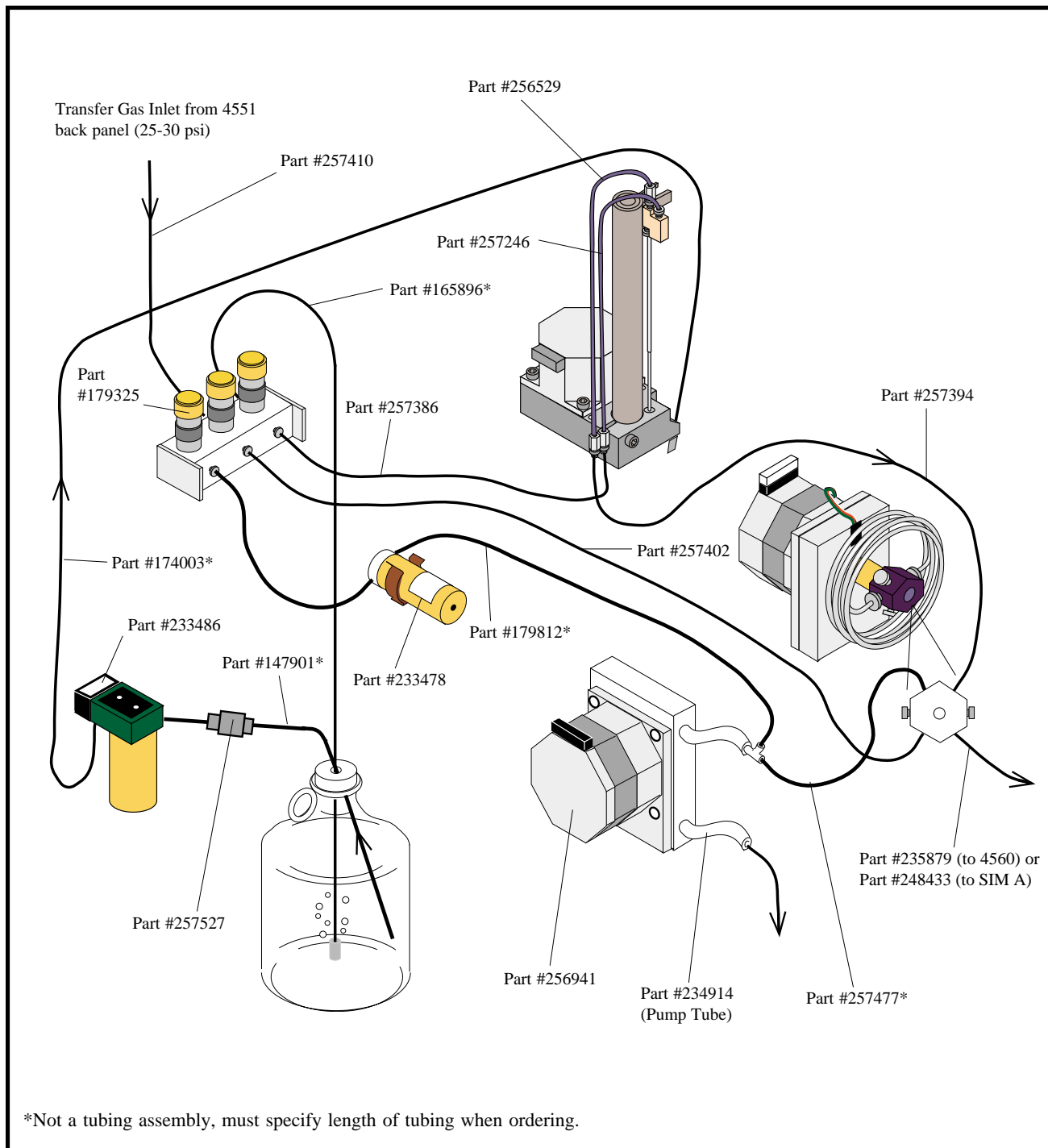



SIM/Spiker Option Injection Sequence

