

Cable Installation Instructions

Cable Part Number: 14-6689-086; 14-6689-186

Interfacing a Tekmar® 2000/7000/3000/6000/Velocity XPT to a Hewlett-Packard 6890 GC (all detectors)

Introduction

The cables (Figures 1 and 2) allow the HP 6890 GC (gas chromatograph) to send a ready signal to the Tekmar instrument. It also enables the Tekmar instrument to start the GC upon sample transfer or injection.

If you are using a 2000 or 7000, you must set switches on the I/O (input/output) circuit board to ensure that electronic signals transfer to the GC. **If you are using a 3000, 6000, or Velocity XPT you do not need to set switches, but you must configure or program the unit to acknowledge the GC.**

These instructions tell you how to connect four different Tekmar instruments to the HP 6890 GC. Follow the instructions that pertain to the instrument you are using.

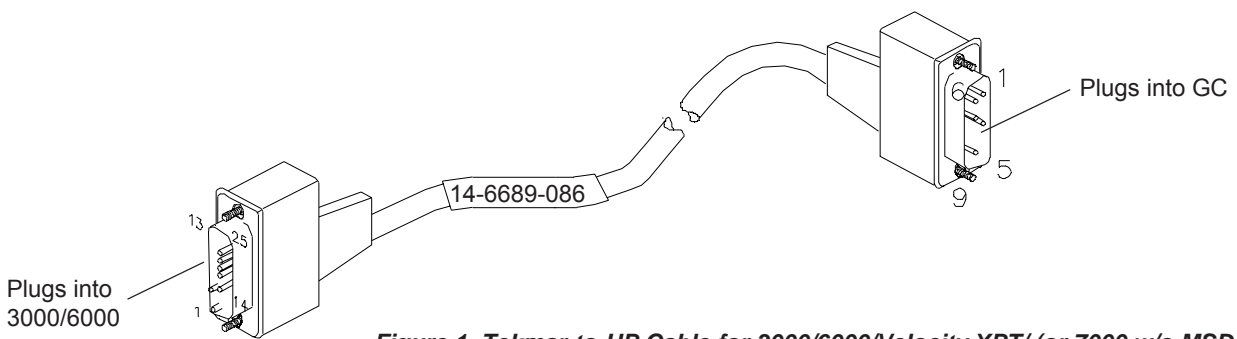

Figure 1 Tekmar-to-HP Cable for 3000/6000/Velocity XPT/ (or 7000 w/o MSD)

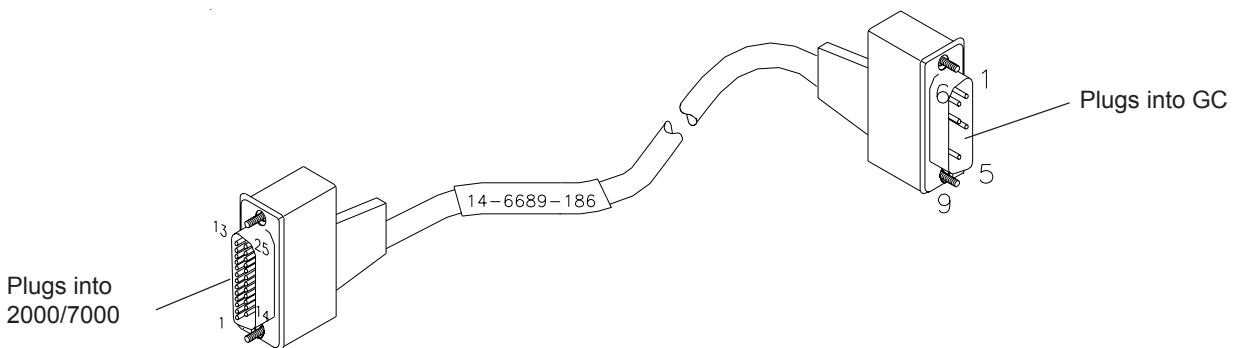

Figure 2 Tekmar-to-HP Cable for 2000 and 7000 w/ MSD

Safety



To prevent electrical shock, turn off and unplug the Tekmar instrument before you remove panels.



Discharge of static electricity can damage parts on circuit boards. Do not touch circuit boards unless instructed otherwise.

Connecting the Cable to the 2000

1. Turn off and unplug the 2000.
2. To access and set the switches:
 - a. Referring to the photograph in Section 12 of the user manual, locate the I/O board on the back of the 2000. You can recognize the board by the two connectors that extend out of its bracket.
 - b. Loosen the two screws that hold the I/O board. Slide the board away from the 2000. Locate the switches labeled “U012” and “U013.”
 - c. Referring to Figure 2 below, set the switches. To open the switches, press them down at the open label.
 - d. Install the I/O board into the 2000. Fully seat the board into the connector.
3. Plug the cable’s 25-pin connector into the matching connector on the I/O board.
4. Go to *Connecting the Cable to the GC*.



* Setting 3 open and 4 closed causes desorb closure to occur at beginning of Desorb.
 ** Setting 3 closed and 4 open causes desorb closure to occur at end of Desorb.

Figure 3 Switch Settings on the 2000 I/O Board

Connecting the Cable to the 7000

1. Turn off and unplug the 7000.
2. To access and set the switches:
 - a. Loosen (do not remove) the two fasteners on the lower left side panel.
 - b. To remove the panel, pull it away from the 7000 to release the retaining clips from the chassis. Next, pull the panel toward the front of the 7000 to release it from the locating pins.
 - c. Locate the three switches labeled “bias,” “output,” and “input” on the edge of the I/O board. Referring to Figure 3 below, set the switches. To open the switches, flip the switches up toward the open label.

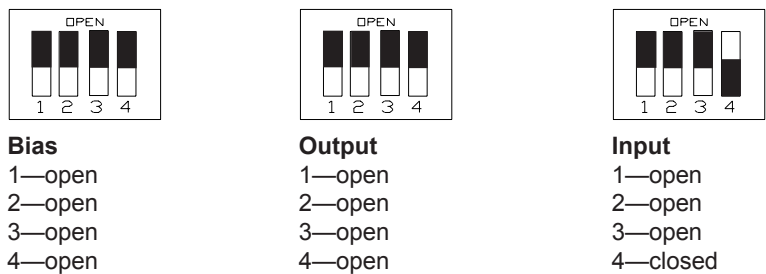

Figure 4 Switch Settings on the 7000 I/O Board

Connecting the Cable to the 7000...

- d. Install the left side panel by pressing it back onto the locating pins. Insert the retaining clips into the posts in the chassis.
- e. Tighten the fasteners.
3. Locate the I/O board on the back of the 7000. You can recognize the board by the two connectors that extend out of its bracket.
4. Plug the cable's 25-pin connector into the matching connector on the I/O board.
5. Go to *Connecting the Cable to the GC*.

Connecting the Cable to the 3000, 6000, or Velocity XPT

1. Turn off and unplug the Tekmar instrument.
2. Referring to Figure 5 below, locate the interface board connector on the back of the Tekmar instrument.

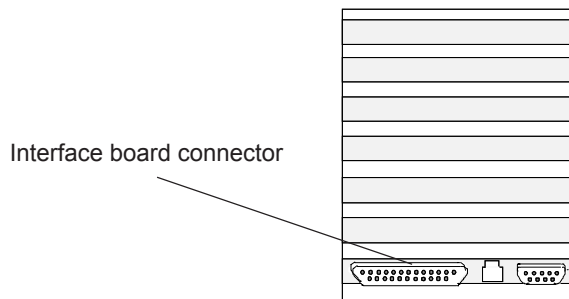

Figure 5 Interface Board Connector

3. Plug the cable's 25-pin connector into the interface board connector.
4. Go to *Specifying the GC Port (3000, 6000 , or Velocity XPT only)*.

Specifying the GC Port (3000, 6000, or Velocity XPT only)

1. Turn on the Tekmar instrument.
2. At the System Error, press the ENTER key.
3. Allow the Tekmar instrument to run through the automatic self tests.
4. At the Standby Screen, press the key labeled CONF. The Configuration Screen appears on the display.
5. At the Configuration Screen, press A (GC I/O Port). The GC Port Screen appears on the display.
6. Two choices (User and Standard) appear on the display. Choose USER. If the cursor is on Standard, press any number key to move the cursor to USER. Then press ENTER.
7. Press the NEXT PAGE key. Enter 31 for the User GC Type Number. Press ENTER to save the entry.
8. Turn off the Tekmar instrument.
9. Go to *Connecting the Cable to the GC*.

Connecting the Cable to the GC

1. Referring to Figure 6 below, locate the two APG remote connectors on the back of the GC. The APG Connectors are near the optional MIO INET card.
2. Plug the cable's 9-pin connector into either one of the APG connectors.

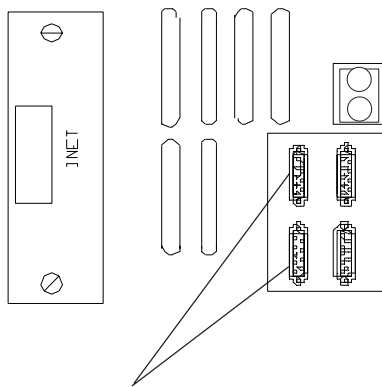

APG remote connectors

Figure 6 Connecting the Cable to the GC

Troubleshooting

If problems occur, make sure that:

- Both ends of the cable are plugged into the correct connectors.
- Cable connections are secure and screws are tight.
- The switches on the 2000 or 7000 are set correctly.
- The 3000, 6000, or Velocity XPT recognizes user for the GC port.
- Pins on the cable connectors are not broken or bent.
- The cable is free of surface damage.

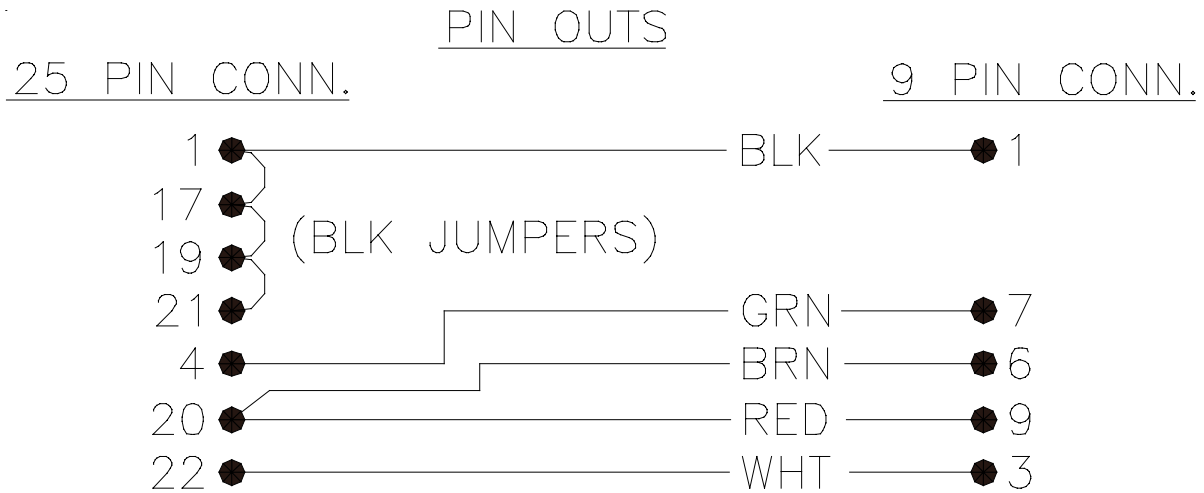

SHIELD MUST BE CONNECTED AT BOTH
ENDS BY HOUSING BODY.

Figure 7 Wiring Diagram for 3000/6000/Velocity XPT Cable (p/n 14-6689-086)

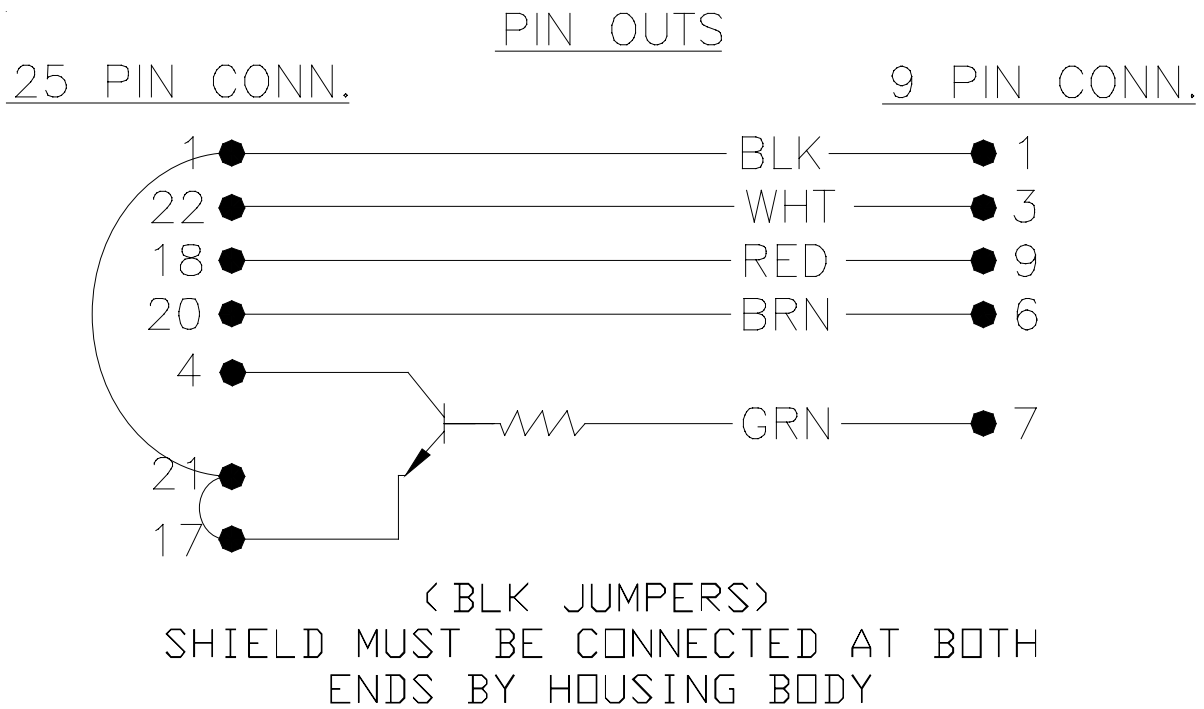

Figure 8 Wiring Diagram for 2000/7000 Cable (p/n 14-6689-186)



Sales/Support: 800-874-2004
Main: 513-229-7000
 4736 Socialville Foster Road
 Mason, OH 45040
www.tekmar.com