



TCC-100

Thermostatted HPLC Column Compartment

Operating Instructions



Revision: 3.00
Date: April, 2004

© 2004 Dionex

Doc.: TCC100_OI_E_V3_0.doc



Declaration of Conformity

Product: Thermostatted HPLC Column Compartment
Type: TCC-100

Dionex GmbH herewith declares conformity of the above products with the respective requirements of the following regulations:

- Low-Voltage Equipment Directive 73/23/EEC
changed by 93/68/EEC
- EMC Directive 89/336/EEC
changed by 91/263/EEC; 92/31/EEC; 93/68/EEC

The electrical safety of the products was evaluated based on the following standard:

- EN 61010-1: 1993
Safety requirements for electrical equipment for measurement, control and
laboratory use
Part 1: General Requirements

The Electromagnetic Compatibility (EMC) of the products was evaluated based on the following standards:

- EN 50081-1: 1992:
Electromagnetic Compatibility (EMC) - Generic emissions standard
Part 1: Residential, commercial and light industry
- EN 50082-1: 1992:
Electromagnetic Compatibility (EMC) - Generic immunity standard
Part 1: Residential, commercial and light industry
- EN 61000-3-2: 1998
Electromagnetic Compatibility (EMC)
Part 3 / Section 2: Limits for harmonic current emissions

This declaration is issued for the manufacturer

Dionex GmbH
Dornierstrasse 4
D-82110 Germering

by the President, Dr. Peter Jochum.
October 8, 2002



DIONEX

Certificate



Certificate no.

CU 72031463 01

License Holder:

Dionex Softron GmbH
Dornierstr. 4

82110 Germering
Germany

Manufacturing Plant:

Dionex Softron GmbH
Dornierstr. 4

82110 Germering
Germany

Test report no.: USA-JK 30381768 001

Client Reference: Burkhard Seyferth

Tested to: UL 61010A-1:2002 R4.02

CAN/CSA-C22.2 No. 1010.1-92+A2:97

Certified Product: Thermostated HPLC Column Compartment

License Fee - Units

Model Designation: TCC-100

7

Rated Voltage: AC 100/120/220V or 240V, 50/60Hz

Rated Power: 162VA

Protection Class: I

Rated Ambient Temperature: 10°-35°C

Appendix: 1

7

Licensed Test mark:



Signatures

Stephan Schmitt
President

Dipl.-Ing. M. Raap
QA Certification Officer

Date of Issue

(day/mo/yr)

14/07/2003

Table of Contents

1	Introduction	1
1.1	How to Use This Manual	1
1.2	Unpacking	2
1.3	Intended Use.....	3
1.4	Federal Communications Commission (FCC) Note	3
2	Overview.....	5
2.1	Product Overview.....	5
2.2	Supported Configurations	5
2.3	Theory of Operation	6
2.4	Column Switching Valve	7
2.5	Front Panel Display and Controls	8
2.6	Safety Precautions	9
3	Installation.....	11
3.1	Location.....	11
3.2	Electrical Connection	12
3.3	Rear Panel Connectors	12
3.3.1	USB	13
3.3.2	LAN.....	13
3.3.3	Digital I/O	13
3.4	Opening the Front Panel.....	14
3.5	Installing a Column	15
3.6	Installing the Eluent Preconditioner.....	16
3.6.1	Installing the Eluent Preconditioner without Column Clips	17
3.6.2	Installing the Eluent Preconditioner with Column Clips	19
3.7	Connecting the Capillaries to the Column Switching Valve	21
3.8	Leak Sensors	22
4	Stand-alone Control	23
4.1	Operation.....	23
4.2	Setting the Leak Detection Mode.....	23
4.3	Operation after a Power Failure	24
5	Automated Control by Chromeleon	25
5.1	General	25
5.1.1	USB Installation	25
5.1.2	LAN Installation.....	26
5.1.2.1	Assigning IP Properties to the Column Compartment (CmIPUtil).....	31
5.1.2.2	Recommendations for Network Operation	34
5.2	Installing the Column Compartment in Chromeleon	35
5.3	Operation with Chromeleon	40
5.4	Column Identification System (Column ID).....	43
5.5	System Wellness and Reliability.....	44
6	Troubleshooting.....	45
6.1	List of the Possible Problems	45
6.2	Chromeleon Error Messages	47

7	Maintenance	49
7.1	General Notes.....	49
7.2	Periodical Maintenance.....	49
7.3	Replacing the Fuses.....	50
8	Technical Information	51
9	Accessories and Spare Parts	53
9.1	Standard Accessories (included in the shipment).....	53
9.2	Optional Accessories.....	53
9.3	Spare Parts.....	54
10	Technical Appendix - Column Switching Valve	55
11	Index	57

1 Introduction

1.1 How to Use This Manual

The layout of this manual is designed to provide quick reference to the sections of interest to the user. However, in order to fully understand the thermostatted column compartment, we recommend that you review the manual thoroughly before beginning operation of the column compartment.

Almost all descriptions in the manual apply to all models of the TCC-100 series. Therefore, the term "the column compartment" is used throughout the manual. If some detail applies to only one column compartment, the column compartment is identified by name.

At various points throughout the manual, messages of particular importance are indicated by certain symbols:

 **Please note:** Indicates general information intended to optimize the performance of the instrument.

 **Important:** Indicates that failure to take note of the accompanying information may result in damage to the instrument.

 **Warning:** Indicates that failure to take note of the accompanying information may result in personal injury.

This manual is provided "as is." Every effort has been made to supply complete and accurate information and all technical specifications have been developed with the utmost care. However, Dionex assumes no responsibility and cannot be held liable for any errors, omissions, damage, or loss that might result from any use of this manual or the information contained therein. We appreciate your help in eliminating any errors that may appear in this document.

The information contained in this document is subject to change without notice.

Chromleon[®] and Summit[®] HPLC are registered trademarks of Dionex Corp. Dionex AutoQ[™] is a trademark of Dionex Corp. All other trade or company names mentioned are subject to the copyright and the property and trademark rights of the respective companies.

All rights reserved, including those for photomechanical reproduction and storage on electronic media. No part of this publication may be copied or distributed, transmitted, transcribed, stored in a retrieval system, or transmitted into any human or computer language, in any form or by any means, electronic, mechanical, magnetic, manual, or otherwise, or disclosed to third parties without the express written permission of Dionex Corp.

1.2 Unpacking

All electrical and mechanical components of the column compartment are carefully tested before the instrument is shipped from the factory. After unpacking, please inspect the compartment for any signs of mechanical damage that may have occurred during transit.

 **Please note:** Immediately report any shipping damage to both the incoming carrier and Dionex. Shipping insurance will compensate for the damage only if reported immediately.

 **Please note:** Keep the original shipping container and the packing material. They provide excellent protection for the column compartment in case of future transit. Shipping the instrument in any other packaging automatically voids the product warranty.

Unpack the column compartment as follows:

- Place the shipping container on the floor and remove the accessories pack and the power cable.
- Grasp the instrument by the sides. Slowly and carefully, pull it out of the shipping container and place it on a stable surface.

 **Important:** To prevent the column compartment from falling, lift the unit itself from the sides. Do not lift the unit by the packaging material or the front panel.

- Remove the foam inserts.
- Check off the contents of the accessory pack against the accessories list (→ Standard Accessories (included in the shipment), page 53).

 **Caution:** When lifting or moving the column compartment, always hold it by the bottom or sides. Lifting the column compartment by the front panel may damage the hinges of the front panel door.

1.3 Intended Use

The column compartment is designed to perform equally well as a dependable system for routine analyses or as a sophisticated research instrument, especially for HPLC (high performance liquid chromatography) applications. The column compartment can be operated manually, from the front panel, or controlled remotely by the Chromeleon Chromatography Management System.

Please note that the column compartment may only be operated with the accessories originally supplied with the instrument (→ page 53) and within its technical specifications (→ page 51).

Use only standard HPLC solvents and buffers that are compatible with components in the flow path of the column compartment. Note the special properties of the solvents such as viscosity, boiling point, UV absorption (UV/VIS detector), and refractive index (refractive index detector).

Buffer concentration: typically up to 1 mol/L.

pH-range: 1-13 (with less than 0.1 mol/L chloride ions)

If there is a question regarding appropriate usage, contact Dionex before proceeding.

Dionex is not liable for any damage, material or otherwise, resulting from inappropriate or improper use of the instrument.

1.4 Federal Communications Commission (FCC) Note

This equipment has been tested and found to comply with the limits for a Class A digital device, pursuant to part 15 of the U.S. FCC Rules. These limits are designed to provide reasonable protection against harmful interference when the equipment is operated in a commercial environment. This equipment generates, uses, and can radiate radio frequency energy and, if not installed and used in accordance with the instruction manual, may cause harmful interference to radio communications. Operation of this equipment in a residential area is likely to cause harmful interference, in which case the user will be required to correct the interference at his expense.

2 Overview

2.1 Product Overview

The column compartment is designed to perform equally well as a dependable system for routine analyses or as a sophisticated research instrument, especially for HPLC applications. The temperature can be set on the instrument itself, using the front panel controls or remotely, via Chromeleon. The design has been optimized for minimum dead volume and maximum efficiency.

Thermoelectric (Peltier) elements heat or actively cool the column chamber and all internal components to the desired temperature. Using a heat exchanger, they allow fast temperature changes and ensure independence from the ambient temperature, even if the temperature set point is below the ambient temperature.

The column compartment allows compartment cooling by max. 15°K from the ambient temperature. The lower temperature limit is +5°C (+41°F). Cooling is often used to keep the column temperature constant. If the ambient temperature increases during the analysis, cooling ensures that the column temperature nevertheless remains constant.

The columns can be warmed up to max. +85°C (+185°F). An increase in temperature from 20°C to 50°C (68°F to 122°F) is realized in less than 20 minutes. This corresponds to an average performance of 2-4°K per minute.

Up to three columns of different length (maximum length: 30 cm) can be installed in the column chamber. An electronic column identification module allows GLP-compliant documentation of the column type and the most important column parameters (→ Column Identification System (Column ID), page 43).

All surfaces of the column compartment are made of plastic to provide maximum resistance to the most commonly used HPLC solvents.

2.2 Supported Configurations

The column thermostat is available in various configurations and can thus be used in numerous laboratory environments.

In addition to the standard column thermostat, two models with an integrated switching valve (2-position/6-port or 2-position/10-port valve) are available for applications that require column switching:

The column thermostat that contains the 2-position/6-port switching valve is, together with a P680A DGP-6 dual low-pressure gradient pump, the appropriate choice for applications, such as matrix separation or concentration of components.

Together with the P680A DGP-6 dual low-pressure gradient pump, the column thermostat with the 2-position/10-port switching valve allows increasing the sample throughput by overlapping injections with offline re-equilibration of two matched chromatographic columns. During this process, offline re-equilibration is performed for one chromatographic column, while the next sample is simultaneously injected and analyzed on the other column.

For an overview of the currently available configurations, refer to the table below. If you have any questions, please contact the Dionex Sales department or your Dionex distributor.

Model	Part No.	Description
TCC-100	5710.0000	Thermostatted column compartment (basic version)
TCC-100 MSV 2P-6P	5710.0010	Thermostatted column compartment with 2-position/6-port switching valve
TCC-100 MSV 2P-10P	5710.0020	Thermostatted column compartment with 2-position/10-port switching valve

For information about the switching valve, refer to Column Switching Valve (→ page 7).

2.3 Theory of Operation

The fundamental requirement for a column compartment for liquid chromatography is the ability to maintain the preset temperature as precisely as possible. However, temperature stability is more important than the absolute precision of the setting. The thermostatted column compartment contains advanced electronic circuits that can maintain the selected temperature with a precision of 0.1°C.

The thermo-optimized design reduces the time required to equilibrate the temperature between the column and the solvent. The Peltier elements heat up and cool down the columns. The heat exchanger inside the column chamber also helps to bring the air and all components in the chamber to the desired temperature. The column switching valve (if installed) is also brought to the corresponding temperature. Two additional eluent preconditioners are provided in the accessories kit and can be installed in the column compartment, if necessary (→ Installing the Eluent Preconditioner, page 16).

These procedures ensure that

- The temperature of the stationary phase remains constant over the total column length.
- The column and the solvent have the same temperature during the analysis.

In this way, analytical separation is performed at the nominal temperature, thus, minimizing fronting and tailing.

2.4 Column Switching Valve

For applications that require two different columns at frequent intervals at similar temperatures, Dionex also offers the TCC-100 Thermostatted Column Compartment with a 2-position/6-port or 2-position/10-port column switching valve (part numbers: 5710.0010 for the TCC-100 with 2-position/6-port valve; 5710.0020 for the TCC-100 with 2-position/10-port valve).

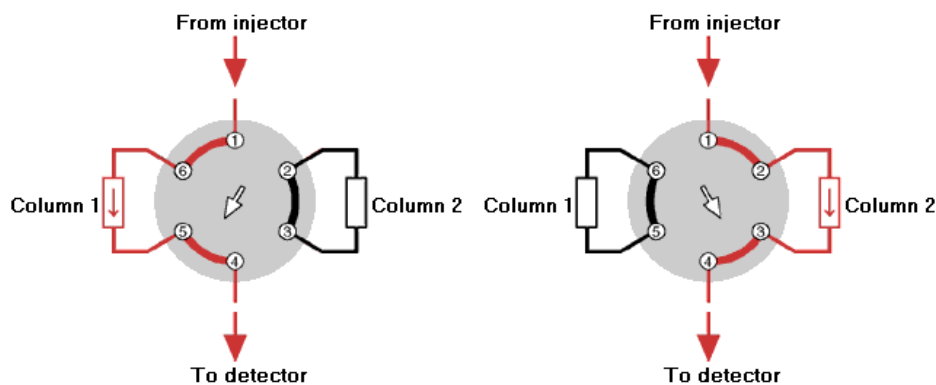

Fig. 1: Typical example for column switching with a 2-position/6-port column switching valve

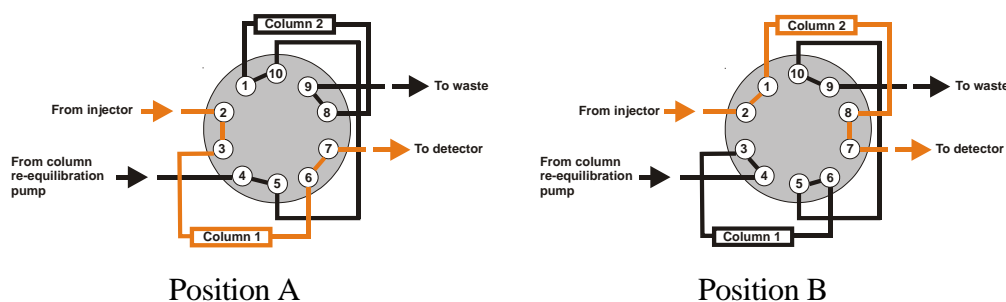



Fig. 2: Example for column switching with a 2-position/10-port column switching valve here: Overlapping injection with offline re-equilibration of the column (In position A, column 1 analyzes while column 2 re-equilibrates. In position B, column 2 analyzes while column 1 re-equilibrates.)

The switching valve automatically selects the column to be used. The valve is installed in the column chamber and is brought to the temperature equilibrium as well. The column switching valve is programmed and controlled via Chromeleon (For details, refer to the Chromeleon online Help). For information about how to connect the capillaries to the valve, refer to Connecting the Capillaries to the Column Switching Valve (→ page 21). For more information about the valve, refer to the Technical Appendix (→ page 55).

2.5 Front Panel Display and Controls





Fig. 3: Front panel

No.	Front Panel Element	Function
1		Switches the instrument to stand-by mode.
2	+	Increases the set point temperature in increments of 0.1°C (→ Operation, page 23) Sets the leak detection mode (→ Setting the Leak Detection Mode, page 23)
3	—	Decreases the set point temperature in increments of 0.1°C (see above) Sets the leak detection mode (see above)
4	Temperature	Indicates the current temperature, the temperature set point, or the leak detection mode. Press the Plus or Minus key to display the temperature set point. Simultaneously press the Plus and Minus keys to display the leak detection mode.
5	LEDs:	
	Heating	Lighted when the column compartments is heating.
	Cooling	Lighted when the column compartment is cooling.
	Remote	Lighted when the column compartment is controlled by Chromeleon.

2.6 Safety Precautions

Please observe the following general safety precautions while operating the instrument or carrying out any maintenance work:

 **Important:** When lifting or moving the column compartment, lift only from the bottom or sides of the instrument. Lifting the column compartment by the front panel may damage the hinges of the front panel door.

 **Important:** Do not place any heavy objects on the open front panel door. This may damage the hinges.

 **Important:** Do not touch any metal parts inside the column chamber while the temperature set point is $> 50^{\circ}\text{C}$ (122°F). Wait for the chamber to cool down, for example before changing a column or before performing any maintenance procedures.

 **Please note:** Use only standard HPLC solvents and buffers that are compatible with components in the flow path of the column compartment. Note the special properties of the solvents such as viscosity, boiling point, UV absorption (UV/VIS detector), and refractive index (refractive index detector).
Buffer concentration: typically up to 1 mol/L.
pH-range: 1-13 (with less than 0.1 mol/L chloride ions)

3 Installation

Bring the unit to a moderate temperature for four hours to allow any condensation that might have occurred during shipping to evaporate. Do not connect the column compartment to the mains yet. After four hours, check the instrument; if the condensation is still there, allow the instrument to continue to warm up (without connecting it to the mains) until the condensation is completely gone.

3.1 Location

Install the instrument in the laboratory on a stable surface that is free of vibration. Make sure that the surface is resistant to solvents. Avoid locations with extreme changes in temperature (such as direct sunlight or drafts) and high air humidity. Allow sufficient clearance behind the instrument for power connections and ventilation. Also, make sure that the ventilation slots on both sides and underneath the instrument are never obstructed in any way.

If the column compartment is part of a Summit HPLC system, we recommend that you stack the single components as shown below. This arrangement optimizes the flow path and ensures a low dead volume.

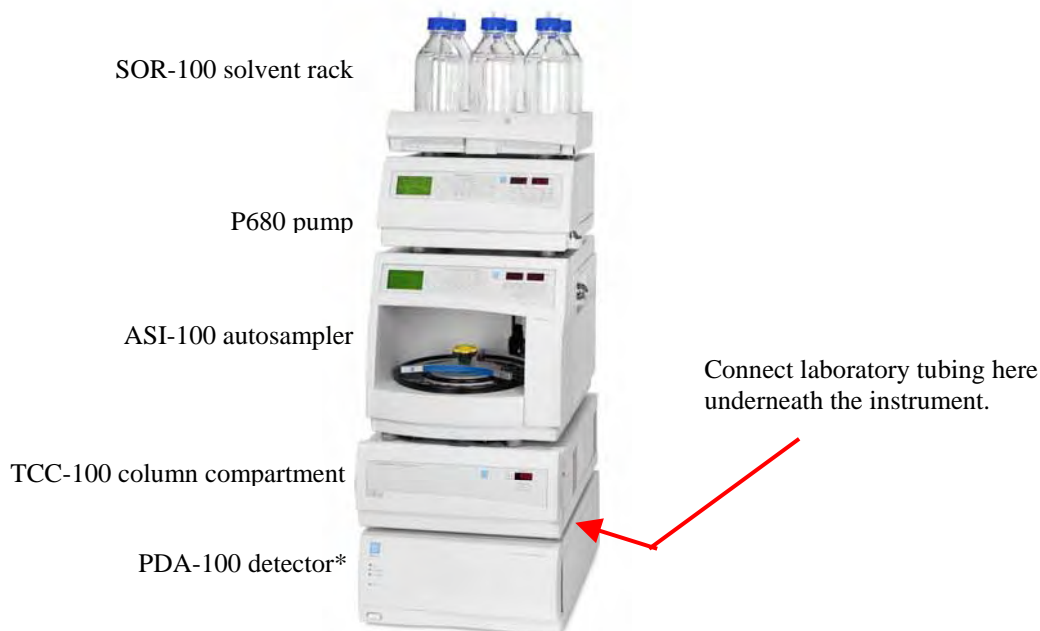

Fig. 4: Summit HPLC system with TCC-100

(* As an alternative, the Summit HPLC system may include a UVD 170U or UVD 340U detector.)

i Please note: Standard laboratory tubing (I.D. = 3 mm) can be connected on the right-hand side, underneath the instrument, to direct liquid leaks to the waste. To prevent damage to the instrument, make sure that no part of the tubing is placed higher than the connecting piece.

3.2 Electrical Connection

Use the power cable provided in the accessories kit to connect the column compartment to the mains. The column compartment is equipped with a standard power unit with an automatic voltage selector. Thus, no adjustment is required to adapt the line voltage to the local voltage requirements.

3.3 Rear Panel Connectors

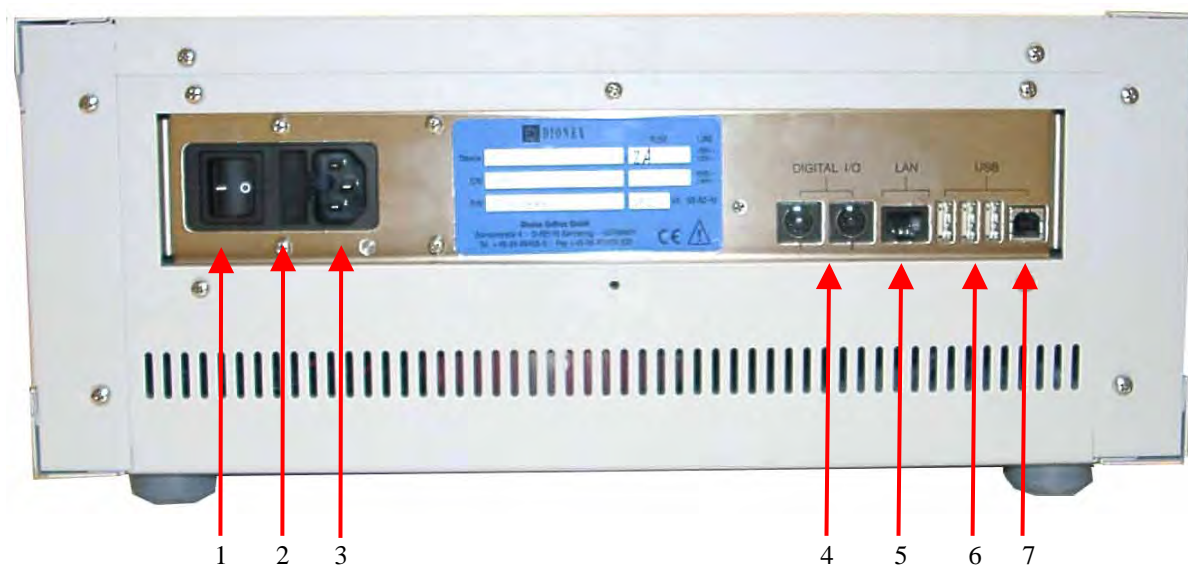

Fig. 5: Rear panel

No.	Description
1	Power switch
2	Fuse cartridge (→section 7.3, page 50)
3	Mains connection (→ section 3.2, page 12)
4	Digital I/O allows you, for example, to synchronize the Inject signal of an autosampler or injection valve with the start of the analysis by the data system (→ section 3.3.3, page 13)
5	LAN (Local Area Network) port allows control of the column compartment by Chromeleon (→ section 3.3.2, page 13)
6	USB (Universal Serial Bus) ports for connection to one Summit HPLC device or USB hub each (→ section 3.3.1, page 13).
7	USB port for connection to the Chromeleon server PC (→ section 3.3.1, page 13).

The Chromeleon Chromatography Management System can use either a LAN or USB connection to control the column compartment. Data is transferred digitally via the appropriate cable (USB cable, part no. 8911.0002; USB extension cable 8911.0004, LAN cable (RJ45 cable for Ethernet hub), part no. 8906.2038). The LAN and USB ports are on the instrument's rear panel (→ Fig. 5).

⚠ Important: To ensure trouble-free operation, all LAN and USB cables (see above) should be ordered from Dionex.

3.3.1 USB

Connect the column compartment to the server PC via the USB port (→ Fig. 5, no. 7). To do so, select one of the following alternatives:

- Connect the column compartment directly to the USB port on the server PC.
- Connect the column compartment to the server PC via another Summit HPLC instrument that is already connected to the server PC.
- Connect the column compartment to the server PC via a USB hub.

The other three USB ports (→ Fig. 5, no. 6) allow the column compartment to be connected to either one instrument in the Summit HPLC product line or one USB hub each. Additional Summit HPLC instruments can then be connected to the hub.

⚠ Important: We recommend using these USB ports (→ Fig. 5, no. 6) for connections to Dionex instruments only. Dionex cannot guarantee correct functioning if non-Dionex instruments are connected.

3.3.2 LAN

The LAN port allows you to connect the column compartment to an instrument LAN (Ethernet). The column compartment supports a data transfer rate of 10 Mbit/sec.

3.3.3 Digital I/O

Two 6-pin Mini-DIN sockets are provided on the instrument's rear panel. They can be used under Chromeleon, as necessary, for connection to external instruments, for example, to synchronize the Inject signal of an external autosampler or injection valve with the start of the analysis by the data system.

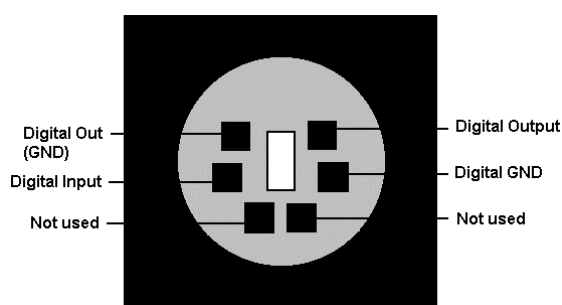

Fig. 6: Digital I/O (view from the rear)

	Description
Digital Input ↔ Digital GND	0 or +5V
Digital Out (GND) ↔ Digital Output	Switching voltage: 100V; switching current: 0.5 A Limiting value of mean on-state current: 1.0 A; Switching capacity: 10W/10VA Volume resistance: max. 150mOhm,

The accessories kit includes a 6-pin Mini-DIN signal cable (part no. 8911.0001). The Analog High, Analog Low, and Shield pins on the connection cable are not supported.

3.4 Opening the Front Panel

The column compartment front panel tilts downward to provide easy access to the columns and capillaries installed in the column chamber. To open the door, press the release button on top of the housing. If the door lock is not released immediately, press the front panel against the enclosure.

Press the release button

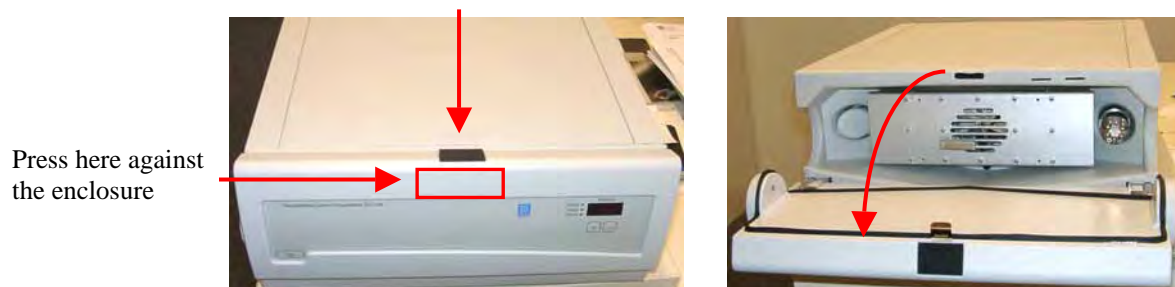

Fig. 7: Tilting the front panel downward

To close the column chamber, tilt the front panel upward until you hear the locking mechanism engage (→ Fig. 8, no. 2)

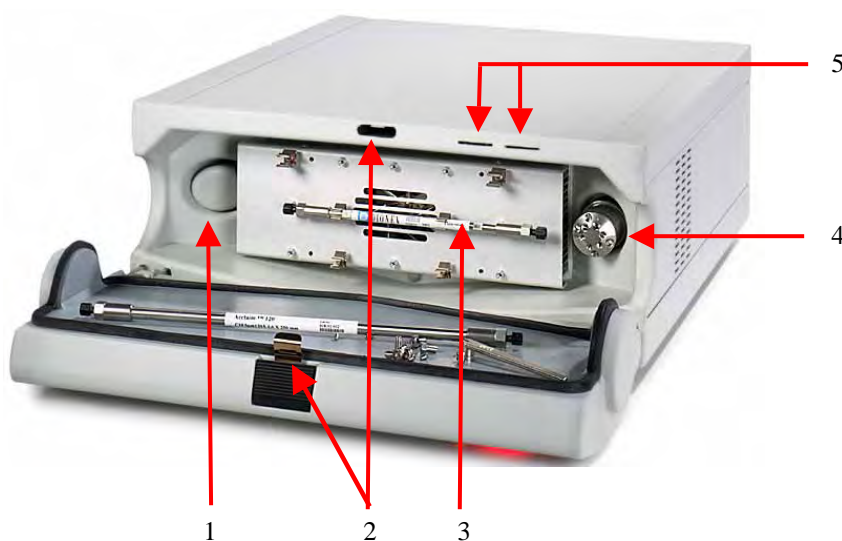

Fig. 8: Open column compartment

No.	Description
1	Leak sensor (humidity and gases)
2	Locking mechanism for the front door
3	Column with column clips
4	Column switching valve (2-position/6-port or 2-position/10-port, if installed)
5	Slots for inserting the chip cards for column identification

* A eluent preconditioner is available as an option and can be installed as desired (→ page 16)

3.5 Installing a Column

- Press the column(s) into the column clip(s) (→ Fig. 9):



Fig. 9: Column in column clip

- Connect the capillaries.

i **Please note:** For information about how to connect the capillaries if a column switching valve is used, refer to section 3.7 (→ page 21).

If you need to move the clips, undo the retaining screws (→ Fig. 10) and tighten the clips into place at the desired location.



Fig. 10: Installing the column clip

You can thread the capillaries out of the interior at any position between the enclosure and the front panel.

i **Please note:** Place the capillaries in such a manner that they do not open a small path for ambient air into the column compartment. This will prevent a proper seal and thus, impair the heating and cooling performance of the column compartment. When cooling, an improper seal may lead to a considerable amount of condensed water.

i **Please note:** If the column compartment is part of the Summit HPLC System, we recommend that you thread the capillaries out of the interior on the right-hand side to ensure that the connections are as short as possible.

3.6 Installing the Eluent Preconditioner

The eluent preconditioner brings the solvent to the column temperature before the solvent enters the column. This avoids temperature gradients on the column.

Two eluent preconditioners are available from Dionex as an option for the column compartment:



Fig. 11: Eluent preconditioners

Description	Part No.
Eluent preconditioner (25 μ l, 26 cm long)	5710.0500
Eluent preconditioner (10 μ l, 10 cm long)	5710.0520

The decision which eluent preconditioner is appropriate for the respective application depends on factors such as the flow rate and the temperature difference between the ambient temperature and the column temperature. For example: For a flow rate of 1 mL/min and a temperature difference of 10°K, install the 10 cm eluent preconditioner. If you want to increase the flow rate to 2 mL/min or if the temperature difference is more likely to be 30°K, we recommend installing the 26 cm eluent preconditioner.

Depending on the application, you can install the column directly on the preconditioner by installing the column clips directly on the preconditioning unit:

- For information about how to install the preconditioner **without** column clips, refer to section 3.6.1 (→ page 17).
- For information about how to install the preconditioner **with** column clips, refer to section 3.6.2 (→ page 18).

3.6.1 Installing the Eluent Preconditioner without Column Clips

(Unlike on the photos, the color of the preconditioner is black (→ Fig. 11).

- Tighten the bottom parts of the preconditioner holders at the desired position in the column chamber.



Fig. 12: Holders (bottom parts) for the eluent preconditioners

- i** **Please note:** Make sure that the ventilation slots inside the chamber are not obstructed in any way.

- Push the eluent preconditioner into the holders and loosely secure the retaining screws.

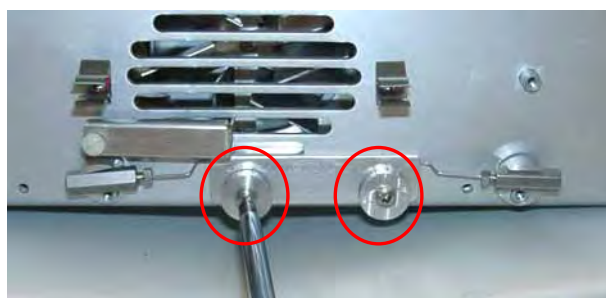

Fig. 13: Retaining screws (here: for the 10 cm eluent preconditioner)

- i** **Please note:** The 26 cm eluent preconditioner is attached with three screws.

- Tighten the top parts of the preconditioner holders into place.



Fig. 14: Holders (top parts) for the eluent preconditioners

- Installation of the eluent preconditioner is now complete.



Fig. 15: Installed eluent preconditioner

- Install the column at an appropriate position in the column chamber.



Fig. 16: Column and eluent preconditioner installed

- Connect the capillary from the autosampler or pump to the preconditioner inlet, connect the preconditioner outlet to the column and then, connect the column outlet to the detector.

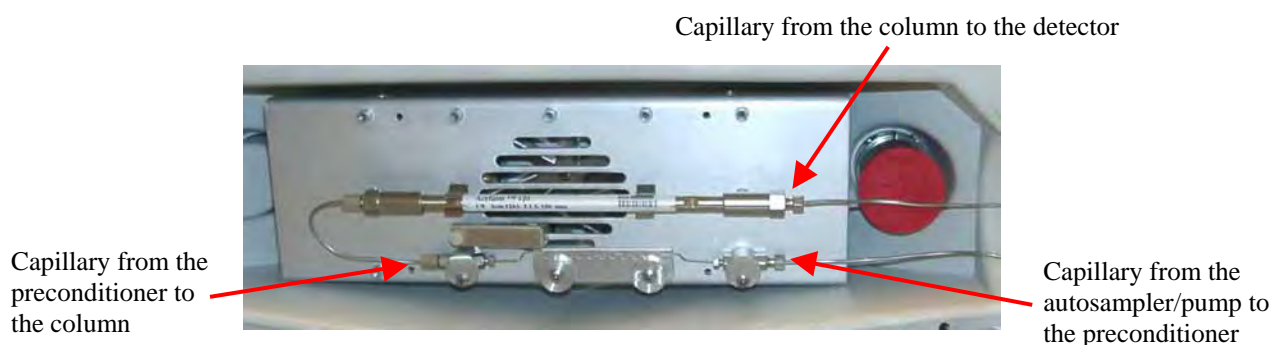

Fig. 17: Eluent preconditioner with the capillaries connected (example)

- i Please note:** Determine the direction of flow through the preconditioner as appropriate for your application, from the right to the left or vice versa.
- i Please note:** For information about how to install the preconditioner **with** column clips, refer to section 3.6.2 (→ page 19).
- i Please note:** For information about how to connect the capillaries if a column switching valve is used, refer to section 3.7 (→ page 21).

3.6.2 Installing the Eluent Preconditioner with Column Clips

(Unlike on the photos, the color of the preconditioner is black (→ Fig. 11).

- Tighten the bottom parts of the preconditioner holders at the desired position in the column chamber and push the preconditioner into the holders as shown below.



Fig. 18: Eluent preconditioner (here: 26 cm unit) inserted in the holders (bottom parts)

i **Please note:** Make sure that the ventilation slots inside the chamber are not obstructed in any way.

- Tighten the center screw using a screw driver.



Fig. 19: Tightening the retaining screws (1)

i **Please note:** Only two retaining screws are required for the 10 cm eluent preconditioner.

- Tighten the other two retaining screws hand-tight.



Fig. 20: Tightening the retaining screws (2)

- Tighten the top parts of the preconditioner holders into place (→ Fig. 14, page 17).
- Install the column clips as shows in Fig. 21.



Fig. 21: Installing the column clips

- Installation of the eluent preconditioner is now complete.



Fig. 22: Eluent preconditioner with column clips

- Press the column into the clips.
- Connect the capillary from the autosampler or pump to the preconditioner inlet, connect the preconditioner outlet to the column and then, connect the column outlet to the detector (→ Fig. 17, page 18).

i **Please note:** Determine the direction of flow through the preconditioner as appropriate for your application, from the right to the left or vice versa.

i **Please note:** For information about how to install the preconditioner **without** column clips, refer to section 3.6.1 (→ page 17).

i **Please note:** For information about how to connect the capillaries if a column switching valve is used, refer to section 3.7 (→ page 21).

3.7 Connecting the Capillaries to the Column Switching Valve

If the column compartment is fitted with a column switching valve, valve switching is programmed and controlled via Chromeleon. (For more information, refer to the Chromeleon online Help.)

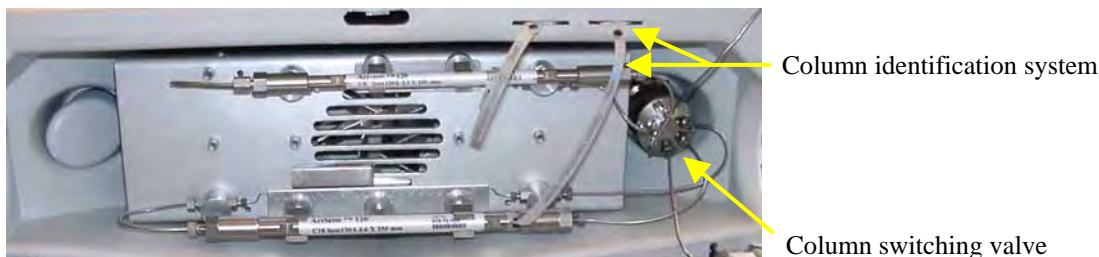

Fig. 23: TCC-100 with column switching valve (here: 2-position/6-port) and 2 columns (here: with column identification system for both columns)

- Remove the plastic cap that protects the switching valve during shipment. Connect the capillaries, using an appropriate tool.



Fig. 24: Removing the plastic cap



Fig. 25: Connecting the capillaries

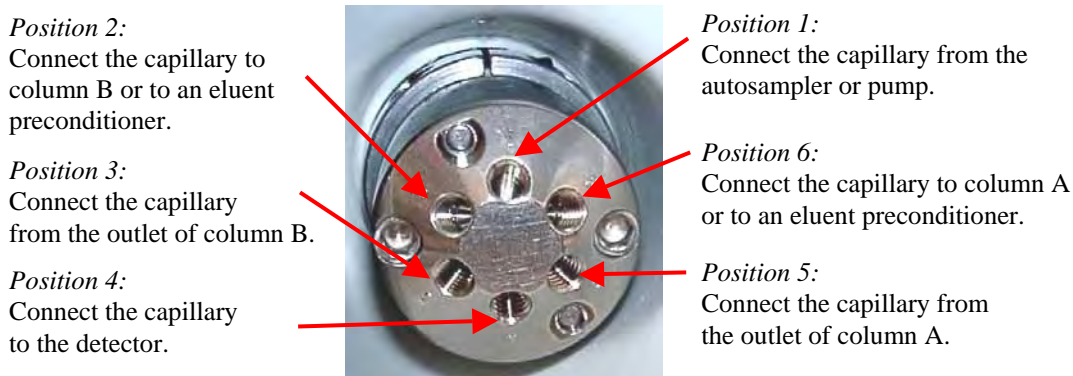

Fig. 26: Typical example for the connections on a 2-position/6-port column switching valve

- i Please note:** If you have connected the inlet capillary of a column to position 6 of a 2-position/6-port switching valve, you must use position 5 for the outlet capillary of this column. The same applies to valve positions 2 and 3.

3.8 Leak Sensors

i **Please note:** Inspect the column compartment for leaks every day. Tighten leaking capillary connections.

The column compartment contains two leak sensors to detect any humidity or gases that may accumulate in the column chamber. If one of the sensors detects a leak, an acoustic beep sounds.

Humidity and gases in the column chamber will be detected by the humidity or gas sensor, respectively. When a certain concentration is reached in the chamber (while the door is closed), the corresponding sensor is activated. To turn off the beep, open the front panel door. Eliminate the leak, wearing the appropriate protective clothing, and ventilate the inside before closing the door again.

i **Please note:** The cleaner the columns and capillaries are, the more reliable is the operation of the leak sensors. If columns and capillaries are wetted with solvent during installation, reliable leak detection is possible only with restrictions.

You can enable and disable the leak sensor function and set the level of sensitivity either via the **Plus** and **Minus** keys on the instrument's front panel (→ page 23) or in Chromeleon (→ **HumidityLeakSensor** and **GasLeakSensor** commands, page 41).

4 Stand-alone Control

Please observe the information about the facility requirements (→ page 11) and the electrical connection (→ page 12). Use the power cord shipped with the column compartment to connect the instrument to the mains. You do not need to take any further action.

4.1 Operation

Turn on the column compartment by pressing the power switch on the rear panel. The temperature display starts flashing. The column compartment is now ready for operation. Press the **Plus** or **Minus** key on the front panel to activate temperature control. The preset temperature set point is displayed for information. The temperature display stops flashing and indicates the actual temperature. The column chamber is heated or cooled to the preset temperature set point.

To interrupt operation without turning off the instrument, set the instrument to standby mode by pressing the **Standby** key on the front panel. To resume operation, press the **Standby** key again.

Use the **Plus** and **Minus** keys to set the temperature for column heating or cooling in increments of 0.1°C. For information about the temperature range, see Product Overview (→ page 5).

Press the **Plus** or **Minus** key to display the preset temperature set point. To increase or decrease the value, press the corresponding key until the display starts flashing. You can change the set point as long as the display is flashing. To change the temperature value more quickly, hold down the key. The display stops flashing when you release the key, and then displays the actual temperature again.

 **Please note:** When you turn off the column compartment, the temperature set point is stored. Therefore, before turning on the column compartment or installing a new column(s), verify that column(s) you plan to use are designed for operation at the pre-set temperature. If necessary, change the temperature set point.

4.2 Setting the Leak Detection Mode

In stand-alone mode, you can enable and disable the leak sensor function on and set the level of sensitivity via the **Plus** and **Minus** keys on the instrument's front panel. Simultaneously press the **Plus** and **Minus** keys to display the leak detection mode setting:

Ld0 = The sensors are turned off

Ld1 = The sensors are turned on; low sensitivity for the gas and humidity sensors

Ld2 = The sensors are turned on; medium sensitivity for the gas and humidity sensors

Ld3 = The sensors are turned on; high sensitivity for the gas and humidity sensors

To modify a setting, simultaneously press the **Plus** and **Minus** keys until the display starts flashing. Turn off the sensors (= 0) or set the desired sensitivity (1, 2, or 3), using the **Plus** or **Minus** key.

After you have entered the desired value, wait for about 7 seconds until the display stops flashing. Do not press any other key during this time. The column compartment then stores the settings and displays the actual temperature value again.

i **Please note:** If the sensitivity has been set in Chromeleon (→ page 41), the setting is saved and remains in effect when the column compartment is disconnected from the data system and operated in stand-alone mode.

If a setting that is not allowed in stand-alone mode has been selected in Chromeleon, e.g., different sensitivity settings for the gas and humidity sensors, the leak detection mode displayed on the instrument reads **LdA**.

4.3 Operation after a Power Failure

As soon as the power returns for a stand-alone column compartment after a power failure, the temperature display flashes. The column compartment is now ready for operation. Press the **Plus** or **Minus** key on the front panel to activate temperature control. The preset temperature set point is displayed for information. The temperature display stops flashing and indicates the actual temperature. The column chamber is heated or cooled to the preset temperature set point.

If the HPLC system is operated by the Chromeleon, you can edit the program file (PGM file) to have the column compartment automatically resume operation after a power-failure, if desired. For more information, refer to the Chromeleon online Help.

5 Automated Control by Chromeleon

5.1 General

If desired, the column compartment can be controlled by the Chromeleon Chromatography Management System. To control the column compartment by the data system, make sure that the following license is available under Chromeleon. (If you have any questions, please contact your Dionex Sales Representative.)

- For Chromeleon \leq 6.40: Device Control license
- For Chromeleon \geq 6.50: Class 1 license

We generally recommend connecting the column compartment to the Chromeleon server PC via USB (Universal Serial Bus). Almost all PCs provide at least one USB port. However, if this is not possible, use a network connection (LAN) for communication between the column compartment and the Chromeleon server. For example, Windows NT 4.0 does not support USB. If you are using a LAN connection, please observe the recommendations for network operation (→ page 34).

For information about how to install the column compartment via USB and LAN, refer to USB Installation (see below) and LAN Installation (→ page 26), respectively.

5.1.1 USB Installation

 Please note: Install Chromeleon software before connecting the column compartment to the USB port on the Chromeleon server PC.

Connect the column compartment to the mains using the power cord shipped with the instrument. Please observe the information about the facility requirements (→ page 11) and the electrical connection (→ page 12). Use the USB cable from the column compartment's accessories kit (→ page 53) to connect the instrument to the USB port on the Chromeleon server PC.

 Please note: The USB connection to the PC or the USB hub must not exceed 5 m. A special USB extension cable (Dionex part no. 8911.0004) is available if a longer connection is required. Up to five extension cables may be connected in series. For system reasons, the overall connection length must not exceed 30 m.

For Chromeleon 6.30 and 6.40, install the column compartment driver via the Setup program on the software CD provided in the accessories kit. Insert the CD into the CD drive of your Chromeleon server PC. Double-click **Setup.exe** in the root directory. Click **Next** to have the Setup program check which Chromeleon version is already installed on your PC. Follow the on-screen instructions as they appear to install the driver. If a version is found for which no driver is available, the setup aborts.

For Chromeleon 6.50 and higher, the USB installation of the column compartment is handled automatically during the Chromeleon setup and you do not have to take any other action.

5.1.2 LAN Installation

! **Please note:** Install the LAN connection under Windows NT 4.0 only. For any other operating systems, we recommend installing a USB connection.

Connect the column compartment to the mains using the power cord shipped with the instrument. Please observe the information about the facility requirements (→ page 11) and the electrical connection (→ page 12). Use the LAN cable from the column compartment's accessories kit (→ page 53) to connect the instrument to the LAN port on the Chromeleon server PC.

To ensure reliable communication between the column compartment and the Chromeleon server with a LAN connection, we recommend using a LAN connection that is independent of the office LAN, i.e., an instrument LAN, between the column compartment and the Chromeleon server PC. This type of connection requires that you install a **separate** 10Mbit network interface card in the Chromeleon server PC and assign **unique** IP addresses to all connected devices. For information about how to install the separate network interface card in the Chromeleon server PC, see page 27.

If your PC already contains a separate network interface card for operating Summit HPLC devices, the column compartment can be connected to this card. For information about how to connect the column compartment using an instrument LAN under Windows NT 4.0, see below.

! **Important:** Dionex cannot guarantee reliable communication when operating the column compartment on an office LAN because the load of the office LAN is a decisive factor. Overload of the office LAN may result in timeouts and loss of data and thus disturb automatic operation of the data system. Therefore, we advise against operating the column compartment on an office LAN.

Connecting the column compartment via an instrument LAN under Windows NT 4.0

If the Chromeleon server PC is running Windows NT 4.0, the column compartment must be connected to the server PC via a LAN. Windows NT 4.0 does not support USB.

If you wish to connect not other instrument but a single column compartment, we can connect the server PC and the column compartment via a **crossover** cable, a special network cable with crossed-over data lines. These lines are usually marked by colors (red, yellow) to distinguish the cable from standard network cables. Thus, the structure of the instrument LAN is as follows (peer-to-peer connection):

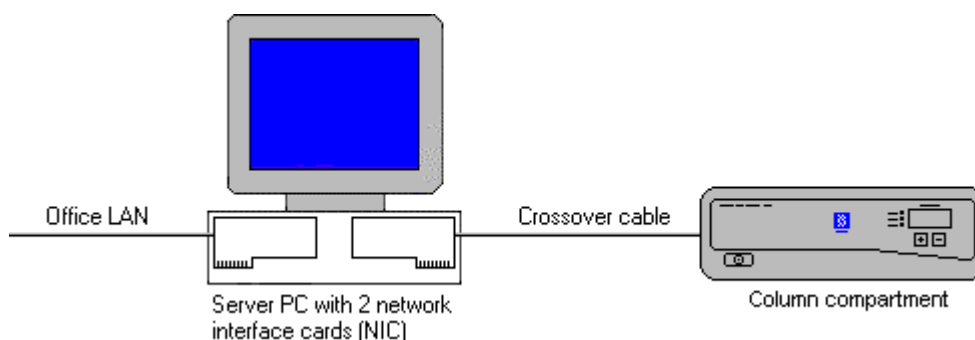

Fig. 27: Peer-to-peer connection

If you wish to connect several TCP/IP-enabled Summit HPLC devices to the server PC, you must use a hub (10 Mbit) to establish the connection to the instrument LAN. In this case, use standard network cables instead of the crossover cable (One standard network cable, part no. 8906.2038, is provided in the accessories kit.)

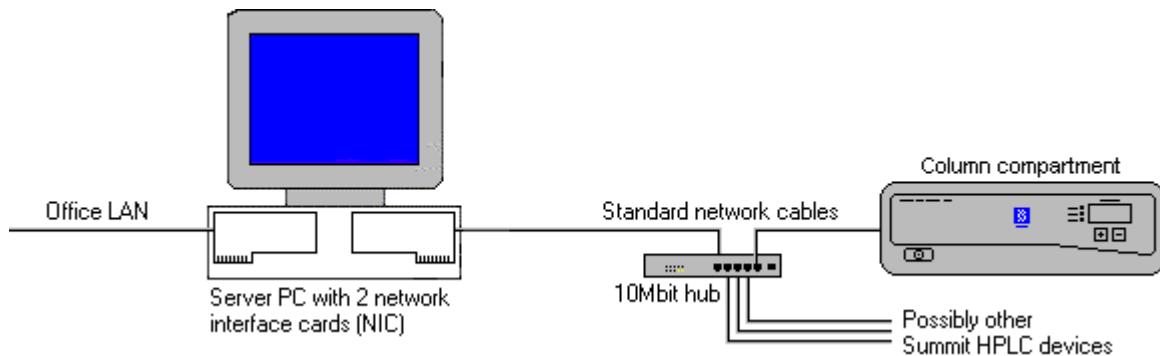

Fig. 28: Hub connection

Separate Network Interface Card (NIC)

A network connection that is independent of the office LAN is called an instrument LAN. This kind of connection between the column compartment and the Chromeleon server requires the installation of a separate 10 Mbit network interface card (NIC, in the operating system = adapter) in the Chromeleon server PC.

Install the card according to the manufacturer's instructions, via **Start** → **Settings** → **Control Panel** → **Network** → **Adapters** → **Add**.

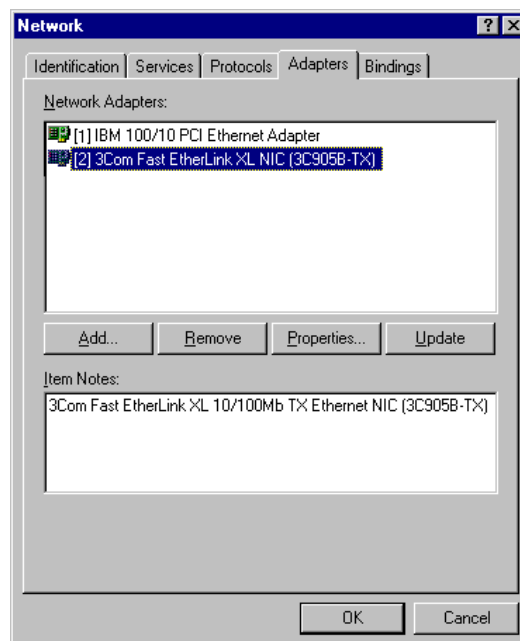

Fig. 29: Installing the separate network interface card

Configure the network adapter for the instrument LAN (here: [2] 3Com Fast EtherLink XL NIC (3C905B-TX)) on the **Bindings** tab page. First, select **all protocols** in the **Show Bindings for** field to verify that the TCP/IP protocol is installed. Install the TCP/IP protocol, if necessary:

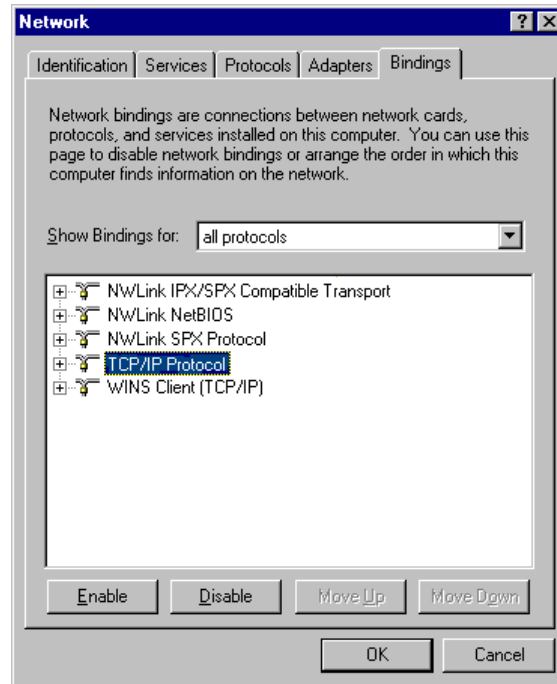

Fig. 30: Show Bindings for all protocols

Then, select **all adapters** in the **Show Bindings for** field and disable all protocols for the adapter for the instrument LAN except the TCP/IP protocol:

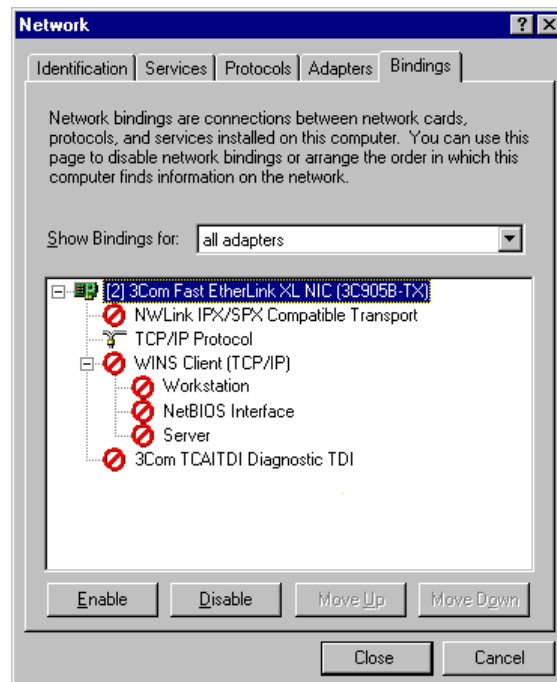

Fig. 31: Show Bindings for all adapters

An IP address and a subnet mask are required for the separate network adapter because the TCP/IP protocol is used for the instrument LAN. The dialog box for entering the IP address and the subnet mask is opened automatically during installation.

i Please note: You can reopen this dialog box later if you need to change the IP address and the subnet mask. Select the properties of the TCP/IP protocol via **Start → Settings → Control Panel → Network → Protocols**. Then, select the TCP/IP protocol and open the **Properties of Microsoft TCP/IP** dialog box, using the **Properties** command on the context menu.

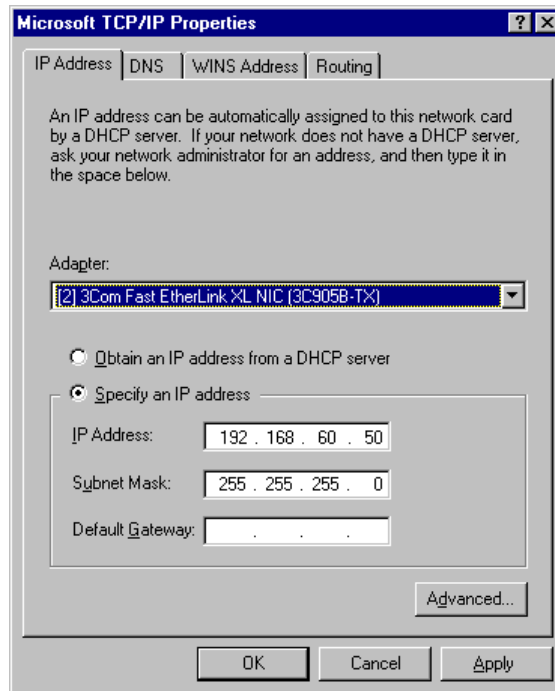

Fig. 32: Assigning the IP address and subnet mask

In the **Adapter** field, select the network adapter for the instrument LAN and enable the **Specify an IP address** option.

! Important: Do not change the settings for the office LAN network interface card!

! Important: For the adapter for the instrument LAN, disable all other network protocols and services (see above).

Assign a fixed IP address to the adapter for the instrument LAN.

First, identify which IP range is already used. To do so, open a DOS command box via **Start → Programs → Command Prompt** and enter: **Ipconfig /all**. Differentiate between the two following cases:

Case A: Already used IP address \neq 192.168.60.xxx

Case B: Already used IP address = 192.168.60.xxx

Note: The subnet mask determines which part of the IP address describes the network and which part defines the individual devices connected to the network. Independent LANs have different network addresses. Based on the subnet mask 255.255.255.0 in the above example, the term "192.168.60" describes the network, while "xxx" defines the individual modules connected to the network.

Case A:

Select the **Specify an IP address** option. Select the address from the range given below and enter the subnet mask specified below:

IP Address: 192.168.60.xxx (xxx can be any number between 1 and 254)
Subnet Mask: 255.255.255.0

Do not enter a gateway address; no gateway is available for the instrument LAN and the above addresses cannot be routed. Communication between the column compartment and the Chromeleon server is always direct.

Case B:

If the range 192.168.60.xxx is already used, use a different network range for the instrument LAN, e.g., use 192.168.61.

 **Important:** In this case, make sure that the addresses assigned to the individual Summit HPLC modules also start with 192.168.61.

For information about the appropriate value for your individual configuration, contact your system administrator.

Do not enter a gateway address; no gateway is available for the instrument LAN and the above addresses cannot be routed. Communication between the column compartment and the Chromeleon server is always direct.

Applies to both, case A and case B

It may happen that the column compartment that you want to control via the separate 10Mbit network adapter has already been assigned an IP address and a subnet mask. In this case, when selecting the IP address of the network adapter of the server PC, be sure that only the last digit differs from the IP address of the column compartment. Otherwise, it may not be possible to address the connected Summit HPLC devices.

Example for a valid configuration for case A:

Column compartment: IP address 192.168.60.**51**
Subnet mask 255.255.255.0

Server: IP address 192.168.60.**50**
Subnet mask 255.255.255.0

Example for a valid configuration for case B:

Column compartment:	IP address	192.168.60. 51
	Subnet mask	255.255.255.0
Server:	IP address	192.168.60. 50
	Subnet mask	255.255.255.0

 **Important:** Every device on the same network must have a unique IP address. Selecting duplicate IP addresses may cause conflicts on the network.

 **Important:** Do not use 0 or 255 as the last numbers in IP addresses.

To check the selected settings, enter the following commands at the DOS level:

```
ipconfig /all
```

What it does: Lists the configuration of all network adapters. The newly installed 10Mbit network adapter has been configured successfully if this command also returns its IP address and subnet mask.

```
route print
```

What it does: Checks whether you can address the column compartment with the network adapter used for the instrument LAN. The new network adapter is correctly configured if the indicated network (here, for example, 192.168.60.0) is displayed under **Target** and its subnet mask under **Net mask**.

```
ping 192.168.60.51
```

What it does: Checks the connection to the column compartment with the IP address 192.168.60.51. If the installation is correct, the column compartment will reply to the ping command.

5.1.2.1 Assigning IP Properties to the Column Compartment (CmIPUtil)

To operate the column compartment on the instrument LAN, an IP address and a subnet mask must be assigned. The program used to assign these IP properties is the **CM IP Utility**.

It is only possible to assign IP properties when data are not being transferred between the column compartment and the Chromeleon server. To stop the Chromeleon server, select **Start** → **Programs** → **Chromeleon** → **Server Monitor**. In addition, the PC on which the CM IP utility is running must be connected to the same subnet as the column compartment you are assigning IP properties.

- If necessary, copy the **CmIPUtil** program from the software CD to a separate directory on your computer.
- Double-click the Setup.exe file to start installation. Follow the installation instructions as they appear on the screen.
- Open the program via **Start → Programs → Chromeleon → IP Utility → CmIPUtil**.

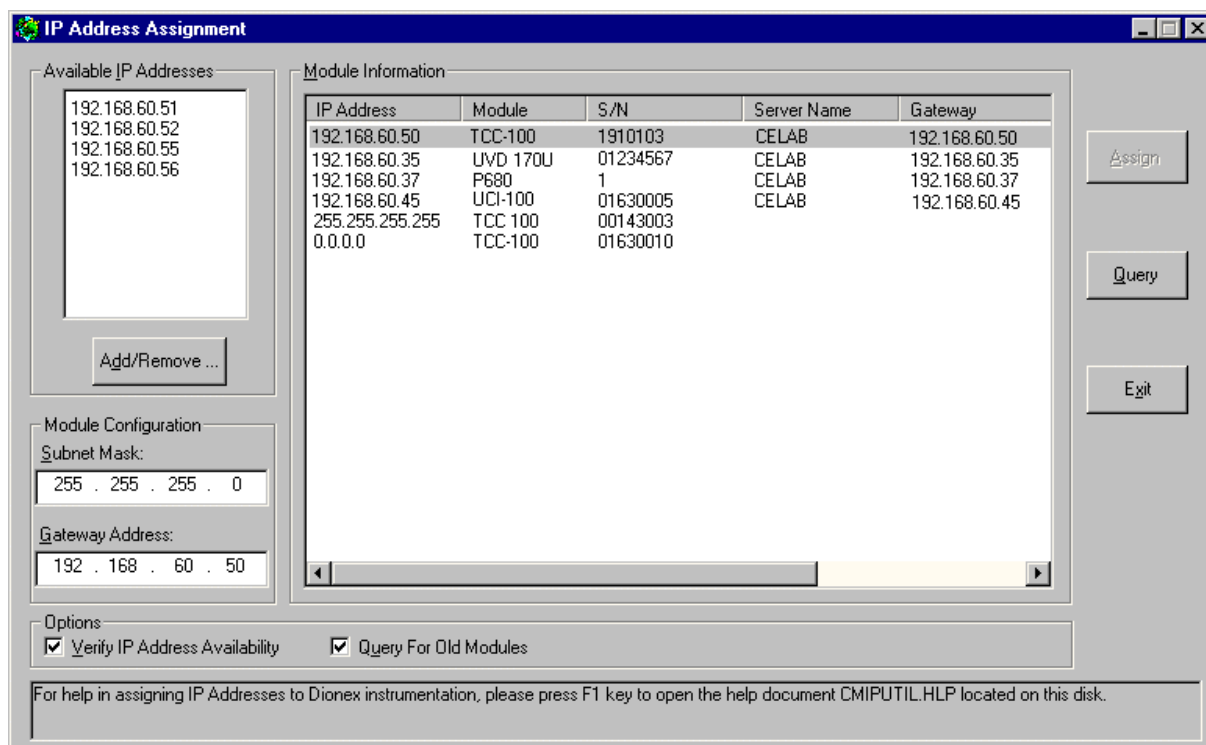

Fig. 33: Assigning IP properties (CmIPUtil)

The **Module Information** window of the **IP Address Assignment** dialog box lists all modules that are active on the network, together with their IP address, serial number (S/N), server name (the name or IP address of the server with which the module exchanges data), gateway address, subnet mask, and Ethernet address. The IP address for modules that have not yet been configured is 0.0.0.0 or 255.255.255.255 (→ Fig. 33).

- Enter the IP address and the subnet mask for the modules to be configured. The values depend on the settings for the adapter for the instrument LAN (→ page 30).
 - Select the module to be configured by its serial number.
 - In the **Available IP Addresses** window, select the IP address to be assigned to the column compartment. If it is not listed, click **Add/Remove** to enter the desired address.
 - Enter the required subnet mask. Select the subnet mask assigned to the Chromeleon server PC.
- When selecting the IP address of the network adapter of the server PC, be sure that only the last digit differs from the IP address of the column compartment. Otherwise, it may not be possible to address the connected Summit HPLC devices.

Example for a valid configuration:

Column compartment: IP address 192.168.60.**51**
Subnet mask 255.255.255.0

Server: IP address 192.168.60.**50**
Subnet mask 255.255.255.0

To configure several TCP/IP-enabled Summit HPLC devices, make sure that every device has its own IP address. In this example, the following entries would be possible:

2. TCP/IP-enabled device: IP address 192.168.60.**52**
Subnet mask 255.255.255.0

3. TCP/IP-enabled device: IP address 192.168.60.**53**
Subnet mask 255.255.255.0

 **Important:** Every device on the same network must have a unique IP address. Selecting duplicate IP addresses may cause conflicts on the network.

 **Important:** Do not use 0 or 255 as the last numbers in IP addresses.

- The **Gateway Address** field must not be empty, although no gateway is available for the instrument LAN. Therefore, enter the IP address of the device to be configured in this field to prevent a gateway from being used.
- When you finish entering IP properties, assign them to the module by clicking **Assign**. After about 1 second, the instrument's new parameters will be displayed in the Module Information window.
- Click the **Query** button to check the settings.
- Click **Exit** to close the program.

 **Important:** Verify that a unique IP address has been assigned to all Summit HPLC devices that are connected to the Chromeleon server PC.

For more information, please refer to the CmIPUtil online Help.

5.1.2.2 Recommendations for Network Operation

Unlike USB connections, Ethernet LAN connections have limited real-time capabilities. Data transmission can occur only when no other connected user is using the network. In order to take full advantage of the real-time capabilities of the column compartment, select the instrument LAN connection (→ page 26). This ensures that other network users do not delay the server communication.

If the column compartment is connected to the data system via a LAN, it is not advisable to use the digital inputs of the column compartment for remote inject synchronization. This is because the timing of LAN communication varies, depending on the current LAN traffic.

If the column compartment is connected to the data system via USB, all remote inputs are polled after 0.1 seconds and they can be used without restrictions.

i **Please note:** Dionex cannot guarantee reliable communication when operating the column compartment on an office LAN because the load of the office LAN will be a decisive factor. Overload of the office LAN may result in timeouts and loss of data, and thus disturb automatic operation of the data system. Therefore, we advise against operating the column compartment on an office LAN.

5.2 Installing the Column Compartment in Chromeleon

Install the column compartment in the Chromeleon Server Configuration program:

- Start the Server Monitor program by selecting **Server Monitor** on the **Start** → **Programs** → **Chromeleon** menu on the task bar. **Start** the server and **close** the Server Monitor window. The Server Monitor icon appears on the task bar.

 **Please note:** Clicking the **Quit Monitor** button quits (exits) the Server Monitor program, but it does not stop the server. To stop the server, click the **Stop** button.

- Start the Server Configuration program by selecting **Server Configuration** on the **Start** → **Programs** → **Chromeleon** menu on the taskbar.
- If necessary, click the "+" character beside the server name to display the items under the server.
- Select the timebase to which you want to add the column compartment.
- Select **Add Device...** on the **Edit** or context menu.
- Select **Dionex** from the left list box, and then select **TCC-100 Column Thermostat** from the right list box. (For Chromeleon versions earlier than 6.50, select **Dionex TCC-100 Column Thermostat** from the drivers list.) Click **OK** to confirm your selection.

The installation wizard is opened. Use the **General** and **Configuration** wizard pages to configure the instrument as desired.

 **Please note:** You may as well open these pages later again to change the settings. Select the **Dionex TCC-100 Column Thermostat** in the Chromeleon Server Configuration program, and then select **Properties...** on the context menu. In addition to the **General** and **Configuration** tab pages, you can also access the **Relays**, **Inputs**, and **Error Levels** tab pages.

General Tab Page

Define the general instrument parameters:

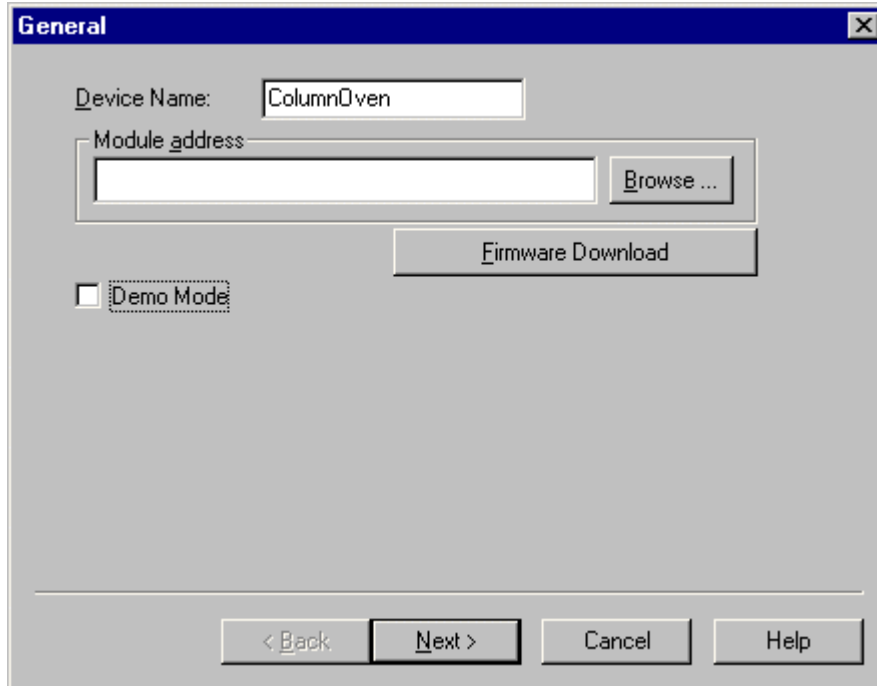

Fig. 34: General tab page

- Verify that **Demo Mode** is disabled. (If Demo Mode is enabled, the **Module address** section and the **Firmware Download** button are disabled.)
- The **Device Name** field indicates the name under which the column compartment is identified in the installation environment. Do not change the default device name (**ColumnOven**).

i **Please note:** If you change the default device name, the links to the corresponding control panels may no longer be available.

- Click the **Browse...** button to select the **Module address** of the desired column compartment. This opens a window showing information about all available installed column compartments (USB and LAN connections).

Address	S/N	Server Name	Ethernet
USB-01610103	01610103@CLABOR_NT		00-E0-EF-DE-00-01
192.168.60.52	01610105	0.0.0.0	00-E0-EF-DE-00-02

Fig. 35: Device list

The **Address** column lists all available modules. The entry that is available via Ethernet (TCP/IP) includes the module's IP address. The entry for a module that is available via USB (identified by the prefix "USB") includes the module's Ethernet address or serial number.

If a module listed here is already connected to a Chromeleon server, the server name appears in the **Server Name** column. If a module is available for connection, the column shows 0.0.0.0 or is empty.

The **S/N** column lists the module's serial number and the name of the computer to which the module is connected while the Chromeleon server is running. The **Ethernet** column shows the module's Ethernet address.

Select the desired column compartment by double-clicking. The module's address is automatically entered in the **Module Address** field on the **General** tab page.

- Click the **Firmware Download** button to download the current firmware version from the data system to the column compartment. The current firmware version is displayed here, as well as the version of the file that is available in the **\Bin** directory of your Chromeleon installation (TCC100.HEX).

Click **OK** to start the firmware download. Please note that the Chromeleon server needs to be in **running idle** mode before the download can be started. The download takes several minutes. To make sure that the firmware is downloaded correctly, do not perform further actions while the download is running.

 **Important:** During the download, make sure that communication between the column compartment and Chromeleon is not interrupted and do not turn off the instrument. Otherwise, the entire firmware may be lost. If the download is not successful, contact Dionex Service.

Configuration Tab Page

Use the **Configuration** tab page to determine the configuration of the column compartment:

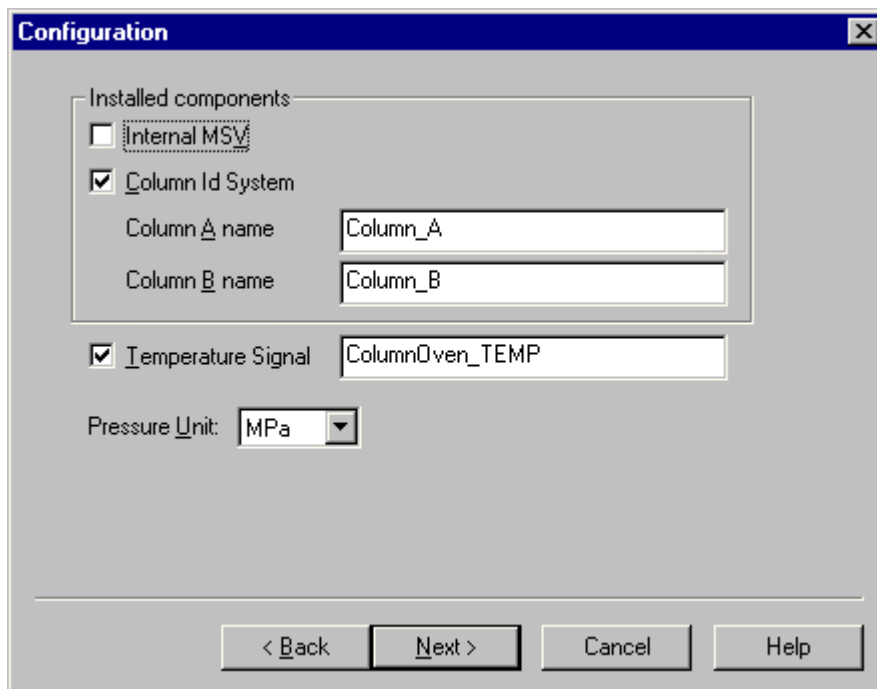

Fig. 36: Configuration tab page

Option	Description
Internal MSV	Select this check box if the column compartment is equipped with a column switching valve.
Column Id System	This check box is selected by default. Accept the setting if you want to use the column identification system and the corresponding properties. For more information, see page 40. Accept the default names (Column_A , Column_B) under which the columns are identified in the installation environment or enter new names. If you change the default device name, the links to the corresponding control panels may no longer be available. Deselect this check box if you do not want to use the column identification system.
Temperature Signal	Select the check box if you want to record the temperature as a separate channel. For more information, see page 40. Accept the default name, ColumnOven_TEMP , under which the temperature signal is identified in the installation environment or enter a new name. If you change the default device name, the links to the corresponding control panels may no longer be available.
Pressure Unit	Determine the pressure unit to be used by the software. The following options are available: bar, MPa, and psi.

Relays Tab Page

The **Relays** tab page lists all available relays. (To access this tab page, select the column thermostat in the Server Configuration program, and then select **Properties...** on the context menu.) Click a check box to enable or disable the corresponding relay. Make sure that the required relays are selected; if they are not, they will not be available in Chromeleon.

Option	Description
TCC_RELAY_1	Relay 1
TCC_RELAY_2	Relay 2

Inputs Tab Page

The **Inputs** tab page lists all available remote inputs. (To access this tab page, select the column thermostat in the Server Configuration program, and then select **Properties...** on the context menu.) Click a check box to enable or disable the corresponding input. Make sure that the required remote inputs are selected; if they are not, they will not be available in Chromeleon.

Option	Description
TCC_INPUT_1	Remote input 1
TCC_INPUT_2	Remote input 2

Error Levels Tab

The **Error Levels** tab page classifies the severity of any errors that occur. (To access this tab page, select the column thermostat in the Server Configuration program, and then select **Properties...** on the context menu.) It is generally not necessary to change the default settings.

Finally, save and close the changed server configuration.

 **Important:** Before turning off the column compartment, always "**disconnect**" the unit in Chromeleon.

For more information about how to configure the column compartment, refer to the Chromeleon online Help.

5.3 Operation with Chromeleon

Chromeleon can control the column compartment in two ways:

- Directly, via the icon and menu commands or via the controls on the corresponding control panel.
- Via time-based programs (PGM-File or programmable buttons).

The following commands and properties are available; some of them are displayed only in Expert mode and/or if the corresponding check boxes have been selected in the Server Configuration program. (For information about how to enable Expert mode, refer to the Chromeleon online Help.)

Commands/ Properties in Chromeleon	Description
ActiveColumn	This command is available only if you have selected the Column Id System check box in the TCC-100's properties (on the Configuration tab page in the Server Configuration program; → page 38). Determine for which column the column identification information shall be updated (A (1) or B (2)). The names are replaced with the names entered on the Configuration tab page in the Server Configuration program.
Column_A Column_B	These commands are available only if you have selected the Column Id System check box in the TCC-100's properties (on the Configuration tab page in the Server Configuration program; → page 38). The names are replaced by the column names entered on the Configuration tab page in the Server Configuration program. Underneath these commands, various commands, and properties allow you to enter and read out information about the column. For more information, refer to the Chromeleon online Help.
ColumnOven_TEMP	This signal is available only if you have selected the TemperatureSignal check box in the TCC-100's properties (on the Configuration tab page in the Server Configuration program; → page 38). Using this command, you can then record the temperature as a separate channel. The name is replaced by the name entered on the Configuration tab page in the Server Configuration program. Click the "+" character beside the name to display the items underneath: Delta —indicates the signal's slope, i.e., the difference between the current value and the value one second ago. This is useful for triggers. Signal —has the following commands: Value (current signal value, read-only), UpperLimit and LowerLimit . If the current signal value is outside these limits, a warning appears in the Audit Trail. AcqOff —terminates data acquisition. AcqOn —starts data acquisition. Retention —indicates the retention time of the signal (read-only). MaxAutoStep = Maximum step rate for Auto Step Mode; range: 0.1...5.1 s; default: 5.1 s Step —sets the step for data acquisition; range: 0.01...4.80 s; Auto selects the best step dynamically Average —averages all measured values over the step interval. Default: On. Off records only the last point of each interval.
Connect	Connects the column compartment to Chromeleon (also see Connected , Disconnect).
Connected	Indicates whether the column compartment is connected to Chromeleon; that is, whether the column compartment is under computer control (also see Connect , Disconnect).

Commands/ Properties in Chromeleon	Description
Disconnect	Disconnects the column compartment from Chromeleon (also see Connected, Connect).
Door	Indicates whether the compartment door is open or closed (Open or Closed ; read-only).
EquilibrationTime	Range: 0.0...30.0 min. Only if the deviation between the current temperature and the set point specified under ReadyTempDelta does not exceed the EquilibrationTime , the column compartment enters the Ready state (also see ReadyTempDelta and Ready).
FirmwareVersion	Indicates the compartment's firmware version (read-only).
GasLeak	Indicates whether the gas sensor has detected a leak (Ok or Leak ; read-only).
GasLeakSensor	Sets the sensitivity with which the sensor responds to gas. Click the arrow in the GasLeakSensor combo box and select the desired option from the list: Low, Standard, or High . To turn the sensor off, select Off .
HardwareVersion	Indicates the compartment's hardware version (read-only).
HumidityLeak	Indicates whether the humidity sensor has detected a leak (Ok or Leak ; read-only).
HumidityLeakSensor	Sets the sensitivity with which the sensor responds to humidity. Click the arrow in the HumidityLeakSensor combo box and select the desired option from the list: Low, Standard, or High . To turn the sensor off, select Off .
Leak	Indicates whether at least one leak sensor has detected a leak (Ok or Leak ; read-only; also see HumidityLeak, GasLeak).
LeakSensorState	Indicates whether the sensors are ready for leak detection (Ready, NotReady, Error ; read-only).
MaxPosition	If a column switching valve is installed and the Internal MSV check box is selected on the Configuration tab page in the Server Configuration program (→ page 38), the maximum number of positions of the installed valve is indicated (read-only).
ModelNo	Indicates the device type (read-only).
MsvPosition	If a column switching valve is installed and the Internal MSV check box is selected on the Configuration tab page in the Server Configuration program (→ page 38), the valve is switched to the desired position (A (1) or B (2)).
Ready	Indicates whether the compartment is ready to operate (Ready or NotReady ; read-only; also see ReadyTempDelta and EquilibrationTime).
ReadyTempDelta	Range: 0.0...5.0°C. If the current temperature deviates from the temperature set point by more than the ReadyTempDelta , the column compartment enters the NotReady state. If the ReadyTempDelta is set to '0', the system does not check whether the temperature set point deviates from the actual temperature (also see Ready and EquilibrationTime).
SerialNo	Indicates the serial number of the column compartment (read-only).
TCC_INPUT_1	Indicates the state of digital input 1 (On or Off).
TCC_INPUT_2	Indicates the state of digital input 2 (On or Off).
TCC_RELAY_1	Relay 1. Click the "+" character beside the relay name to display the items underneath: State —indicates the state of the relay. Duration —when set, the relay toggles after the specified time. On —turns the relay on. Off —turns the relay off.

Commands/ Properties in Chromeleon	Description
TCC_RELAY_2	Relay 2. Click the "+" character beside the relay name to display the items underneath: State —indicates the state of the relay. Duration —when set, the relay toggles after the specified time. On —turns the relay on. Off —turns the relay off.
TempCtrl	Turns temperature control on or off.
Temperature	Range: 5.0...85°C. Click the "+" character beside the name to display the items underneath: Value —indicates the actual temperature. Nominal —allows you to enter the temperature set point. UpperLimit —allows you to enter the upper temperature limit. LowerLimit —allows you to enter the lower temperature limit. If the temperature set point is outside these values, an error message appears in the Audit Trail.
Vendor	Indicates the device manufacturer (read-only).

For information about individual commands and parameters and about the command syntax, open a Chromeleon control panel. Select **Command...** on the **Control** menu. The **Commands** dialog box is opened. You can also open this dialog box by pressing the F8 key. In the left list box, click the "+" character beside **ColumnOven** to display the items underneath.

For more information (also about any parameter or command that might not be listed here), refer to the Chromeleon online Help.

 **Important:** If you press the Standby key on the instrument's front panel while the column compartment is under Remote control, all instruments connected to a USB hub on the instrument's rear panel are also disconnected from Chromeleon.

 **Please note:** When the column compartment is connected to data system, the front panel **Remote** LED is lighted and column compartment is completely controlled and programmed via Chromeleon. It is not possible to change the settings on the instrument's front panel.

While the column compartment is under Chromeleon control, you can nevertheless display the temperature set point and the leak detection mode on the instrument's front panel by pressing the **Plus** or **Minus** key (set point) or by pressing both keys simultaneously (leak detection mode).

There are five leak detection modes:

Ld0 = The sensors are turned off.

Ld1 = The sensors are turned on. In Chromeleon, the sensitivity for the gas and humidity sensors has been set to **Low**.

Ld2 = The sensors are turned on. In Chromeleon, the sensitivity for the gas and humidity sensors has been set to **Standard**.

Ld3 = The sensors are turned on. In Chromeleon, the sensitivity for the gas and humidity sensors has been set to **High**.

LdA = In Chromeleon, a setting not allowed in stand-alone mode has been selected; for example, different sensitivity settings for the gas and humidity sensors.

If the sensitivity is set in Chromeleon, this setting remains valid when the column compartment operated in stand-alone mode after being disconnected from the data system.

5.4 Column Identification System (Column ID)

The column compartment is fitted with a column identification system (part no. 5710.1505) that allows you to store column-specific information on a chip card and read it out whenever you want.

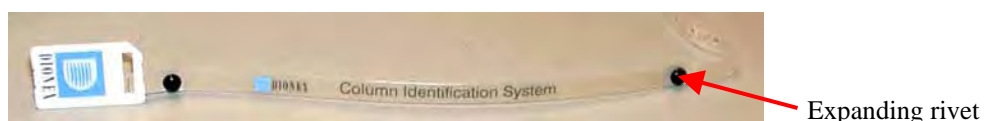

Fig. 37: Column Identification System (Column ID)

- Clip the memory chip card onto the column as shown in Fig. 38. (To do so, you can open the expanding rivet by removing the rivet head from the body.)



Fig. 38: Clipping the memory chip card onto the column

- Insert the chip card (with the Dionex logo facing up) in one of the two column ID slots.



Fig. 39: Inserting the memory chip card into a column ID slot

i Please note: Column identification is supported for two columns simultaneously.

- To store and read out the column-specific information, use the **ActiveColumn** and **Column_A** and/or **Column_B** parameters from the Chromeleon **Commands** dialog box (→ page 40). These parameters are available only if you have selected the **Column Id System** check box in the TCC-100's properties (on the **Configuration** tab page in the Server Configuration program; → page 38). The stored information can then provide a GLP-compliant overview of the column status.

i **Please note:** To open the "**Commands**" dialog box, open a Chromeleon control panel and then, press the F8 key or select **Command...** on the **Control** menu. You can also open this dialog box by pressing the F8 key. In the left list box, click the "+" character beside **ColumnOven** to display the items underneath.

For more information about the Chromeleon column ID, refer to the Chromeleon online Help.

5.5 System Wellness and Reliability

To help you detect small problems before they become big ones, Chromeleon supports different System Wellness and reliability commands and properties, such as temperature limit monitoring, door status monitoring, and the column ID features. If an error is found, an error message is displayed and the error is logged in the Chromeleon Audit Trail.

For more information, please refer to the Chromeleon online Help.

6 Troubleshooting

6.1 List of the Possible Problems

The following table provides a summary of possible operating problems, lists probable causes, and suggests remedial actions:

Problem	Probable Cause	Remedial Action
No temperature display.	<p>The column compartment is not connected to the mains.</p> <p>The power is turned off.</p> <p>The column compartment is in standby mode.</p> <p>The fuses blow.</p> <p>Replacement fuse blows immediately.</p> <p>Error in the electronic system.</p>	<p>Connect the power cord.</p> <p>Turn on the power.</p> <p>Press the Standby key on the instrument's front panel.</p> <p>Replace the fuses (→ section 7.3, page 50)</p> <p>Please contact your Dionex service representative.</p> <p>Please contact your Dionex Service Representative.</p>
The temperature does not change for some time although the temperature set point has not been reached.	<p>The ambient temperature is too high.</p> <p>The ventilation slots on the sides and/or bottom of the instrument are obstructed.</p> <p>The front panel door of the column compartment is not completely closed.</p> <p>The capillaries are placed in such a manner that ambient air can enter the column chamber.</p> <p>The door seal is damaged.</p>	<p>Reduce the ambient temperature (e.g., by ventilating the room).</p> <p>Make sure that the ventilation slots are not obstructed in any way.</p> <p>When closing the door, make sure that the locking mechanism locks the door.</p> <p>Make sure that the capillaries rest flat on the edge of the housing (→ Note on page 15).</p> <p>Please contact your Dionex Service Representative.</p>
The column compartment works correctly in stand-alone mode but not when controlled by Chromeleon.	<p>There is no connection between the column compartment and the Chromeleon server PC.</p> <p>You attempt to connect to a Windows NT 4 computer via a USB.</p> <p>The USB port on the computer is not ready for operation.</p>	<p>Check the USB or LAN connection.</p> <p>Connect the column compartment to the computer, using a LAN connection.</p> <p>Check the USB port on the computer.</p>

Problem	Probable Cause	Remedial Action
The system has very high backpressure.	<p>The column is contaminated or blocked.</p> <p>The capillaries are blocked or damaged by bending.</p> <p>The eluent preconditioner is blocked.</p>	<p>Rinse or replace the column.</p> <p>Remove the blockage or replace the capillaries.</p> <p>Rinse both the capillary of the eluent preconditioner and the eluent preconditioner itself, using an appropriate solvent. If necessary, replace the eluent preconditioner (→ section 3.6, page 16).</p>
Leaking at the eluent preconditioner.	The system has very high backpressure.	<p>Tighten the fittings on the eluent preconditioner inlet and outlet.</p> <p>→ 'The system has very high backpressure' on page 46</p>
Impaired performance of the eluent preconditioner.	<p>The flow path is not correct.</p> <p>The eluent preconditioner is not installed correctly, i.e., the thermal contact is imperfect.</p> <p>The calibration of the column compartment is incorrect.</p> <p>The eluent preconditioner is defective.</p>	<p>Check and correct the flow path, if necessary.</p> <p>Reinstall the eluent preconditioner (→ section 3.6, page 16).</p> <p>→ Please contact your Dionex Service Representative.</p> <p>Replace the eluent preconditioner (→ section 3.6, page 16).</p>
The display is flashing indicating 'Sen' and 'Err' instead of the temperature.	A temperature sensor is defective.	Turn the instrument off and on again. If the message appears again, please contact your Dionex Service representative.
The display is flashing indicating 'Pel' and 'Err' instead of the temperature.	The Peltier elements are too hot.	Turn the instrument off and on again. If the message appears again, please contact your Dionex Service Representative.

6.2 Chromeleon Error Messages

If communication between the data system and the column compartment cannot be established, an error message is displayed in the Chromeleon Audit Trail. The following table lists the most important error messages, along with possible causes and the corresponding remedial actions.

⚠ Important: Please keep in mind that for up to 30 seconds after a change to the server configuration, messages referring to the previous configuration may still be displayed. These messages can be ignored. Thus, always note the device name (TCC100@...) indicated in the message.

ℹ Please note: The error messages below may also read either **TCC100@ + serial number** (= TCC100@USB-01610103) or **TCC100@ + IP address** (= TCC100@192.168.50.1), depending on the connection type (USB or LAN) specified for the column compartment in the Server Configuration.

Message	Probable Cause	Remedial Action
Error opening TCC100 - Connection refused.	<p>Another Chromeleon server already uses the indicated column compartment.</p> <p>The existing connection is not yet completely cleared.</p> <p>The column compartment's subnet mask and gateway address are incorrect.</p> <p>A gateway may maintain an unintended connection to the column compartment as soon as the Chromeleon server is not stopped correctly.</p>	<p>Check that the correct column compartment was selected or terminate the column compartment's communication with the Chromeleon server.</p> <p>Wait for 30 seconds and repeat the procedure.</p> <p>Make sure that the correct parameters are specified (→ section 5.1.2.1, page 31).</p> <p>Restart the column compartment.</p>
Error opening TCC100 - Connection timed out.	<p>The Chromeleon server failed to connect to the indicated column compartment.</p> <p>The network connection is interrupted during firmware download.</p> <p>The network connection is interrupted during firmware download.</p>	<p>Verify that the column compartment is turned on and that the network connection is working.</p> <p>Note the name of the indicated column compartment. It is possible that Chromeleon server is trying to connect to a column compartment that is no longer part of the server configuration. Make sure the Module Address is correct and retry.</p> <p>Check the network connection.</p> <p>Check the mains connection of the column compartment.</p>
TCC100 - Connection reset by peer.	<p>The power supply to the column compartment is interrupted for a short period.</p>	<p>Check the mains connection of the column compartment.</p>

Message	Probable Cause	Remedial Action
TCC100 - Host not found.	Network problems: no connection to the column compartment.	Check the network settings for the column compartment and network interface card. The network connection between the Chromeleon server and the column compartment might be inappropriate (→ section 5.1.2.2, page 34). (Contact your network administrator.)
TCC100 - Permission denied.		
TCC100 - Network is unreachable.		
TCC100 - No route to host.		
UVD TCC100@ USB-00-E0-EF-DE-XX-XX - Device not found on the USB.	The USB connection between the column compartment and the Chromeleon server is interrupted. The power supply to the column compartment is interrupted.	Check the USB connection. Check the mains connection of the column compartment.
Error opening TCC100@ USB-00-E0-EF-DE-XX-XX – The System cannot find the file specified	The USB connection between the column compartment and the Chromeleon server is interrupted. The power supply to the column compartment is interrupted.	Check the USB connection. Check the mains connection of the column compartment.
Error issuing control request to TCC100	The Chromeleon server cannot connect to the specified column compartment.	Check the USB or LAN connection. Check the mains connection of the column compartment. Remove the column compartment specified in the message from the server configuration or else select a different column compartment from the list of available column compartment in the server configuration (via Properties/Browse).
Error reading from TCC100 @ USB-00-E0-EF-DE-XX-XX Data error (cyclic redundancy check)	There is a transmission error between the column compartment and the Chromeleon server.	Check the USB connection. The connection to the next hub must not exceed 5 m. The overall connection length, including the hub connections must not exceed 30 m (→ page 25). Replace any defective USB cable or hub.
Error reading from TCC100 @ USB-00-E0-EF-DE-XX-XX	The connection between the column compartment and the Chromeleon server is interrupted. The power supply to the column compartment is interrupted.	Check the USB connection. Check the mains connection of the column compartment.

For a list of all Chromeleon error messages, see the Chromeleon installation program (= **Server Configuration**). Double-click the column compartment in the left window section and select the **Error Levels** tab page in the dialog box. You can also open the dialog box by clicking the column compartment in the left pane and then selecting the column compartment's **Properties** on either the **Edit** menu or context menu.

7 Maintenance

7.1 General Notes

The column compartment is made of high-quality components and materials, which minimize maintenance requirements. The painted surfaces, as well as the display, are relatively resistant to weak acids, alkali, and organic solvents. Nevertheless, immediately wipe up all liquids spilled onto the column compartment's surface, using a lint-free cloth or paper. If surfaces are exposed for longer periods, these liquids can cause damage!



Warning: Keep in mind that the fluid components of the column compartment may be filled with toxic solvents. Therefore, purge the column compartment with an appropriate solvent and put on protective clothing before starting maintenance work.



Important: Before you return any instrument to Dionex for repair, contact Dionex Service or your local distributor. An RMA (Return Material Authorization) number is required for the return so that we can properly track and account for your instrument. Always use the original packaging when shipping the column compartment. Shipping the instrument in anything other than the original packaging will void the warranty. Refer to the warranty statement in the terms of sale for more information.



Important: Use original Dionex spare parts only. Substituting non-Dionex parts may impair column compartment performance, thereby voiding the product warranty. Refer to the warranty statement in the terms of sale for more information.

7.2 Periodical Maintenance

Perform the following routine maintenance procedure at regular intervals:

- Clean the column chamber, using a lint-free cloth. Use paper to absorb any humidity in the column chamber. The cleaner the column chamber is, the better the leak sensor is at detecting leaks.
- Inspect the column compartment for leaks. Tighten leaking capillary connections. If necessary, replace the fittings and/or ferrules.
- Inspect the seal installed in the instrument's front panel door. A defective door seal impairs the performance of the instrument. If the seal is defective, please contact your Dionex Service Representative.
- Check the contact between the eluent preconditioner (if installed) and the heat exchanger to ensure perfect thermal contact. If necessary, reinstall the eluent preconditioner (→ section 3.6, page 16).

i Please note: For information about maintenance procedures for the column switching valve, refer to Technical Appendix - Column Switching Valve (→ page 55).

All other maintenance procedures must be performed by Dionex Service personnel. Have a Dionex Service Representative check the column compartment once a year to prevent contamination, excessive wear, etc. If unexpected problems occur, please contact your Dionex Service Representative.

7.3 Replacing the Fuses

STOP Warning: Before replacing the fuses, turn off the column compartment. Be sure to disconnect the power cord from its source.

! Important: Use only the fuses indicated below or those listed in the Accessories/Spare Parts List (→ page 53).

Description	Part No.
2A Fuse, idle, 5 x 20 mm	Included in TCC-100 Fuses Kit, part no. 6710.9001

To replace the fuses:

- Remove the fuse cartridge, using a small screwdriver.



Fig. 40: Fuse cartridge

- Replace the fuses with fuses of the appropriate rating.

i Please note: Always install two fuses.

- Reinstall the fuse cartridge.
- Reconnect the power cord to its source and turn on the column compartment.

8 Technical Information

Environmental Conditions:	Range of use: Indoor use Temperature: 10°C to 35°C (50°F to 95°F) Air humidity: 40 to 85% rel. humidity, non-condensing Overvoltage Category: II Pollution degree: 2
Operating Conditions:*	Temperature range: +5°C to +85°C (+41°F to +185°F) When cooling: max. 15°K from ambient
Temperature Setting:	In 0.1°C increments
Temperature Accuracy:	± 0.5°C
Temperature Stability:	± 0.1°C
Temperature Precision:	± 0.1°C
Heat-up/Cool-down Time:	Less than 20 minutes from 20°C to 50°C Less than 20 minutes from 50°C to 20°C average change per minute: 2-4°K
Column Capacity:	3 columns (maximum length: 30 cm)
Control:	All functions controllable via LAN or USB Permanent status transfer Program-controlled by Chromeleon or stand-alone operation
I/O Interfaces:	Digital I/O: 2 inputs, 2 relay outputs
Switching Valve:	Options: 2-position/6-port or 2-position/10-port switching valve Maximum backpressure: 345 bar (5000 psi) Switching time: 110 ms
GLP:	When controlled by Chromeleon: Dionex AutoQ routines for Instrument Qualification Column identification system for 2 columns
PC Connection:	USB or Ethernet (RJ-45; 10 MBit)
Additional USB Ports:	Integrated USB hub with three type A USB ports for connection of other Summit HPLC modules
Safety Features:	Leak sensor (humidity/gas sensor)
Instrument Panel:	3-digit LED for current and set temperature output 2 temperature set button ('Plus' and 'Minus') 3 LEDs indicating the instrument status (Heating/Cooling/Remote)
Power requirements:	Max. 165 W (100-120V, 60 Hz; 200-240V, 50 Hz)
Dimensions (h x w x d):	18 x 39 x 48 cm (7 x 15.5 x 19 in.)
Weight:	TCC-100 standard configuration: 15.1 kg (33.3 lbs) TCC-100 with column switching valve: 16.2 kg (35.7 lbs)

* This specification only applies to instruments without switching valve.

Technical information: April 2004.

All technical specifications are subject to change without notice.

9 Accessories and Spare Parts

Accessories and spare parts for the column compartment are always maintained at the latest technical standard. Therefore, part numbers are subject to alteration. However, updated parts will always be compatible with the parts they replace. The part numbers always refer to the packing unit. Unless stated otherwise, the packing unit is one unit. For more information, please contact your Dionex Sales Representative.

9.1 Standard Accessories (included in the shipment)

The following accessories are shipped with the column compartment (subject to change without notice).

Description	Part No.*	Quantity in the accessory pack
TCC-100 accessory pack	5710.9000	
Power cord (220 V), 2m or Power cord (125 V), 2m (depending on the destination country)	1310.7031 or 1310.7032	1
2A fuse, idle, 5x20 mm	Included in 6710.9001	2
6.3A fuse, idle, 5x20 mm	Included in 6710.9001	1
6-pin Mini-DIN signal cable (5 m)	8911.0001	1
RJ45 cable for Ethernet connection (3m)	8906.2038	1
Type A to type B USB cable (3m)	8906.2038	1
TCC-100 Column Clips kit including 4 column clips (6 mm) 4 column clips (8 mm)	6710.9002	1
Column ID	Included in 5710.1505	2
TCC-100 Quick Installation Guide	n.a.	1
Operating instructions, English	4827.1051	1
Chromeleon 6 Service Pack-CD	4580.0316	1

* The part number always refers to the packing unit. For more information, please contact your Dionex Sales Representative.

9.2 Optional Accessories

Part No.*	Description
5710.0500	Eluent preconditioner (25 µl; 26 cm)
5710.0520	Eluent preconditioner (10 µl; 10 cm)
5710.1505	Set of column IDs (pkg of 5)
8911.0004	USB extension with signal amplifier (5 m)

* The part number always refers to the packing unit. For more information, please contact your Dionex Sales Representative.

9.3 Spare Parts

Part No.*	Description
6710.9001	TCC-100 Fuses kit including 10 2A fuses, idle, 5 x 20 mm 5 6.3A fuses, idle, 5 x 20 mm
754.C2-20R6	Rotor seal for 2-position/6-port switching valve
754.C2-10R0	Rotor seal for 2-position/10-port switching valve
754.C-2C06	Stator for 2-position/6-port switching valve
754.C-1C00	Stator for 2-position/10-port switching valve
754.SWH4	Socket wrench (1/4") for switching valves
754.ZF1S6	Ferrule (1/16") for 2-position/6-port and 10-port switching valves (pack. unit: 1)
754.ZF1S6-10	Ferrule (1/16") for 2-position/6-port and 10-port switching valves (pack. unit: 10)
754.ZN1-S6	Nut (1/16") for 2-position/6-port and 10-port switching valves

* The part number always refers to the packing unit. For more information, please contact your Dionex Sales Representative.

10 Technical Appendix - Column Switching Valve

VICI Valco Instruments Co. Inc.

Technical Note 801



Cheminert® Models C2, C3, C4, and C5

Cleaning and Rotor Replacement

Initial Precautions

After unpacking the valve, do not remove the protective tape from the valve ports until you are ready to install the valve. As supplied, all surfaces are clean and free of contaminants, and must be kept clean to prevent valve damage. Open ports and fittings cause unnecessary risk of particulate matter entering the valve and scratching the sealing surfaces, which is the most frequent cause of premature valve failure.

NOTE: The most common source of particulate and chemical contamination is tubing which has not been properly cleaned before installation in the valve. To avoid this problem, we suggest purchasing our electrolytically pre-cut and polished tubing, available in standard lengths for any plumbing requirement. If other tubing is to be used, make certain that all tubing ends are free of burrs and cut square with the tube axis, and that all tubing has been chemically and mechanically cleaned.

WARNING

Failure to observe proper cleanliness procedures during installation of the valve voids the manufacturer's warranty.

Make certain that tubes are seated completely before forming the one-piece Valco ferrule on the tube. This insures minimum connection volume. (For further information on installing fittings, refer to **Technical Note 503, Fitting Instructions**).

WARNING

If this valve is replacing a Rheodyne model, do not use the fittings made up in the original valve. The difference in pilot depth yields unswept volume.

Cleaning a valve can often be accomplished by flushing all the lines with appropriate solvents. Do not disassemble the valve unless system malfunction is definitely isolated to the valve.

Disassembly (Refer to Figure 1)

1. Use a 9/64" hex driver to remove the socket head screws which secure the cap on the valve.
2. To insure that the sealing surface of the cap is not damaged, rest it on its outer face. Or, if the tubing is still connected, leave it suspended by the tubing.
3. With your fingers or a small tool, gently pry the rotor away from the driver.
4. Examine the rotor sealing surface for scratches. If scratches are visible to the naked eye, the rotor must be replaced. If no scratches are visible, clean all the parts thoroughly with an appropriate solvent, taking care that no surfaces get scratched. (The most common problem in HPLC is the formation of buffer crystals, which are usually water-soluble.) It is not necessary to dry the rotor.

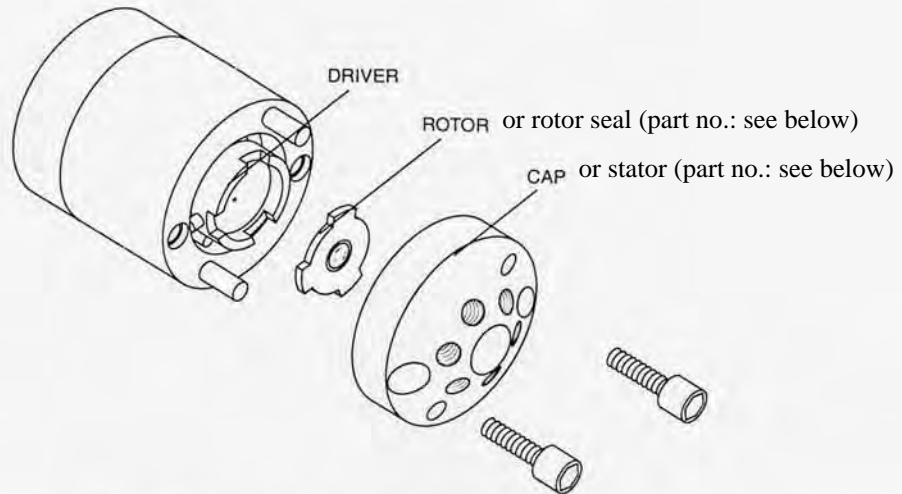

Figure 1: Exploded view of the Model C2 (here: 2-position/6-port valve)

Reassembly

1. Replace the rotor in the driver, making sure that the rotor sealing surface with its engraved flow passages is facing out. The pattern is asymmetrical to prevent improper placement.
2. Replace the cap. Insert the two socket head screws and tighten them gently until both are snug. Do not over-tighten them – the screws simply hold the assembly together and do not affect the sealing force, which is automatically set as the screws close the cap against the valve body.
3. Test the valve by pressurizing the system. If it doesn't hold pressure, the valve should be returned to Valco for repair.

Part No.	Description
754.C2-20R6	Rotor seal for 2-position/6-port switching valve
754.C2-10R0	Rotor seal for 2-position/10-port switching valve
754.C-2C06	Stator for 2-position/6-port switching valve
754.C-1C00	Stator for 2-position/10-port switching valve

Printed in USA © 2000

VICI Valco Instruments Co. Inc.
 P. O. Box 55603
 Houston, TX 77255
 Sales toll-free (800) 367-8424
 Technical help (713) 688-9345
 Fax (713) 688-8106 valco@vici.com

VICI AG

Valco International
 Untertannberg 7
 CH-6214 Schenkon
 Switzerland
 Phone (Int + 41 + 41) 925-6200
 Fax (Int + 41 + 41) 925-6201 vici@vici.com

TN-801 9/00

Cheminerit and VICI are registered trademarks of Valco Instruments Co. Inc. and VICI AG

11 Index

A		I	
Accessories		Inputs (Tab Dialog Box).....	39
Optional.....	53	Installation	11
Standard	53	Column.....	15
Automated Control.....	25	Connections (Rear Panel).....	12
C		Electrical Connection.....	12
Chromeleon		Eluent Preconditioner.....	16, 17, 19
Error Messages.....	47	LAN	26
Installation Program.....	35	Location	11
Operation.....	40	Network Interface Card (NIC).....	27
Server Configuration Program.....	35	USB.....	25
Chromeleon Tab Dialog Boxes		Intended Use	3
Configuration	38	IP Properties Assignment.....	31
Error Levels.....	39	L	
General	36	LAN	13, 26
Inputs.....	39	Leak Detection Mode.....	23
Relays.....	39	Leak Sensors.....	22
CmIPUtil.....	31	M	
Column ID	43	Maintenance.....	49
Column Identification System.....	43	Fuse Replacement	50
Column Installation.....	15	General Notes.....	49
Column Switching Valve.....	7, 21, 55	Periodical	49
Configuration (Tab Dialog Box).....	38	Module Address.....	36
Connection (Electrical)	12	N	
Connections (Rear Panel)	12	Network Interface Card (NIC).....	27
Digital I/O	13	Network Operation	
LAN	13	IP Properties.....	31
USB.....	13	Recommendations	34
Control		O	
Automated.....	25	Operating Instructions.....	1
Stand-alone.....	23	Operation	
Control Elements	8	after Power Failure.....	24
D		Automated.....	25
Digital I/O.....	13	Chromeleon.....	40
Display	8	Control Elements.....	8
E		Display	8
Electrical Connection.....	12	Leak Detection Mode.....	23
Eluent Preconditioner.....	16, 17, 19	Stand-alone	23
Error Levels (Tab Dialog Box).....	39	Optional Accessories	53
Error Messages	47	P	
F		Peer-to-Peer Connection	26
Facility Requirements	11	Power Failure.....	24
FCC Note	3	Product Overview	5
Firmware Download	37	R	
Front Panel.....	14	Rear Panel (Connections)	12
Function Keys.....	8	Digital I/O	13
Fuse Replacement	50	LAN	13
G			
General (Tab Dialog Box)	36		

USB13
Relays (Tab Dialog Box)39
Reliability.....44

S

Safety Precautions.....9
Spare Parts53, 54
Specification51
Stand-alone Control23
Standard Accessories53
System Wellness44

T

Technical Information.....51

Theory of Operation6
Troubleshooting
 Chromeleon Error Messages47
 Possible Problems45
Troubleshooting:.....45

U

Unit Description
 Column Switching Valve7
 Product Overview5
 Theory of Operation.....6
Unpacking.....2
USB.....13, 25