



# Cleaning and Rotor Replacement Instructions

## Low and Medium Temperature Valco Multiposition Valves Air and Electric Actuation

**CAUTION:**

Perform all other system checks before working on the valve. Since any contact between the interior of the valve body and the metal of the rotor is likely to cause damage, do not take the valve apart unless system malfunction is definitely isolated to the valve. If valve disassembly is absolutely necessary, carefully observe the instructions listed below for disassembly, cleaning, and reassembly.

### Disassembly

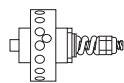

**Valves With External Spring Hardware**

Perform all disassembly operations in a clean, well-lighted area. Flush all hazardous or toxic materials from the valve before starting.

- For a valve on a standoff:** Use a 7/64" hex driver to loosen the 6-32 x 5/8" socket head screw in the clamp on the end of the standoff (*not* the one which holds the standoff to the actuator) and remove the valve from the actuator/standoff assembly.  
**For a closemount valve:** Use a 7/64" hex driver to loosen the 6-32 x 5/8" socket head screw in the clamp ring between the valve and the actuator, and remove the valve from the actuator.
- Using a 7/16" open end wrench or nut-driver, loosen and remove the 10-32 hex nuts from the threaded seal shaft. Slide the coil spring and washers from the shaft, taking care to note their order for reassembly later.
- Grasp the valve firmly and give a slight rotation to the 1/4" shaft of the rotor to break apart the sealing surfaces. Alternatively, grip the valve with the 1/4" shaft pressed firmly into the palm of the hand to restrict its travel and tap the end of the threaded shaft.
- After the sealing surfaces are broken free in the above operation, carefully pull the rotor out of the tapered interior of the valve body.

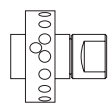

**Valves With a Preload Assembly**

Perform all disassembly operations in a clean, well-lighted area. Flush all hazardous or toxic materials from the valve before starting.

- Unscrew the preload assembly from the valve body. Wrench flats are provided for this purpose. (**Figure 1**)

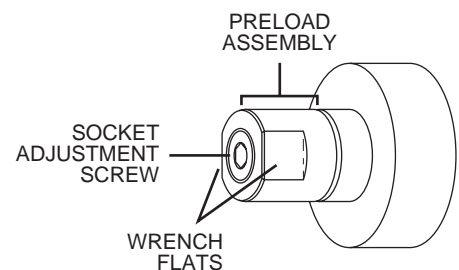

**Figure 1**

- Engage the end of the rotor (**Figure 2**) with a pencil-type magnet, available from Valco or any electronic components supplier.
- Step the actuator through several positions to break apart the sealing surfaces and carefully withdraw the rotor from the valve body with the magnet.
- For a valve on a standoff:** Use a 7/64" hex driver to loosen the 6-32 x 5/8" socket head screw in the clamp on the end of the standoff (*not* the one that holds the standoff to the actuator) and remove the valve from the actuator/standoff assembly.  
**For a closemount valve:** Use a 7/64" hex driver to loosen the 6-32 x 5/8" socket head screw in the clamp ring between the valve and the actuator, and remove the valve from the actuator.

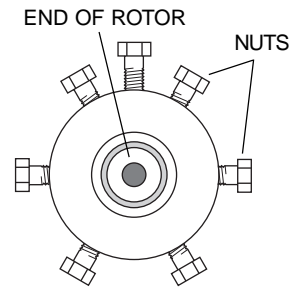

**Figure 2:**  
Valve viewed from  
preload end

## Cleaning

- Using clean dry air, blow any loose debris from the valve body and the rotor.
- Using a strong solvent and an optical quality lint-free wiper such as a Kimwipe, wipe away any loosely bound seal material which may have worn free and adhered to either surface. Avoid using halocarbon solvents if the valve is to be used in a system with electron capture detection, since some of the solvents may persist at the trace level. Consult the Manufacturer's Data Safety sheet for whatever solvent is utilized.

**NOTE:** If the valve has been used with aqueous buffer solutions and some leakage has occurred, wipe the sealing surfaces of the valve with a water-moistened Kimwipe before using a nonpolar solvent to clean any seal material still adhering to the valve's interior.

- Visually inspect the interior of the valve body. The conical surface should appear uniform as well as highly polished. If scratches are visible between the ports or anywhere which suggests a potential leakage path or wear source, the valve should be returned to the factory for regrinding. If the rotor's sealing surface shows any scratches and/or a narrowing of the surface flow passages, replacement is necessary. If the valve body interior is in good condition, a field replacement of the rotor may be effected using the following procedure.

## Assembly and Alignment Procedure (New or Existing Rotor)

The valve will have either one (SD and SC types) or two (SF, ST and STF types) rows of ports evenly spaced around the circumference of the body. See **Figure 3**. In addition there will be one (SD and SF types) or two (SC and ST types) "common" ports offset to either side of these rows. The rotor has either one or two engraved rings; these are the flow passages which intersect the common port(s). Flow passages perpendicular to the ring(s) connect the ring(s) to the selected port(s).

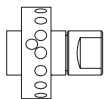

### STUW

The only configuration which does not fit this description is the STUW. STUWs have only one row of ports around the circumference, with two common ports offset in the same direction. The common ports are 180° apart, so the STUW and SDUW (with one offset port) look identical in **Figure 3**. Special instructions for STUW, SDUW, and MW valves are highlighted in this manner at several points in the following procedures.

The alignment procedure is a way of centering the perpendicular engraving on the selected port by determining the point at which flow begins (when the engraving is just beginning to intersect the port) and the point at which flow ends (when the engraving has ceased to intersect the port), and centering the rotor between those two points.

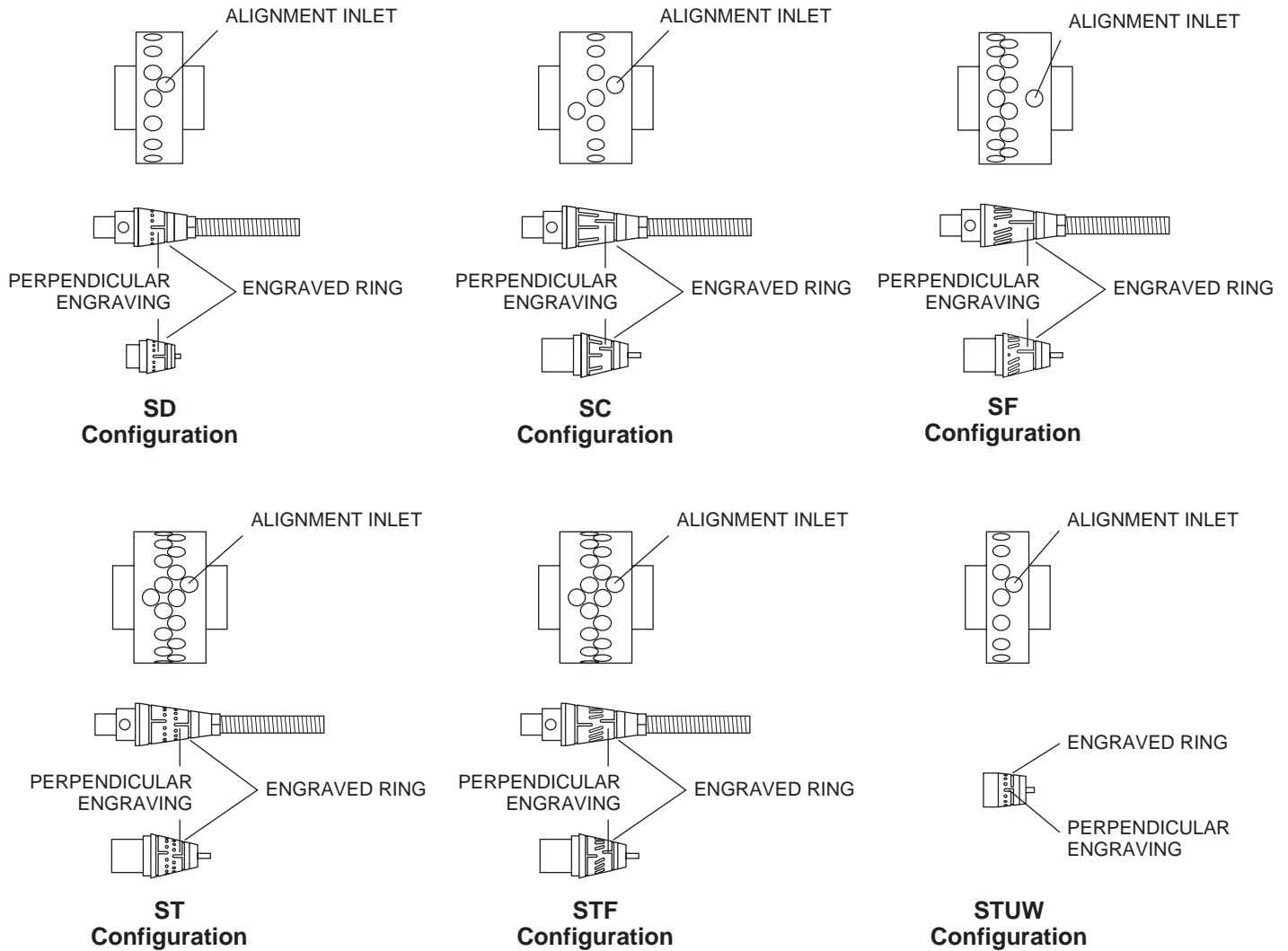
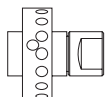

**Figure 3:**

Typical multiposition valve bodies and rotors (external spring hardware rotor shown above preload rotor)

### Assembly and Alignment Procedure *(continued)*

1. Make sure that all sealing surfaces are clean and dry.
2. If a used rotor is to be reinstalled, clean it with a light solvent and blow the passages clean with compressed air. Discard the rotor if any scratches are visible between ports.
3. Locate the common port offset toward the small end of the valve interior. (In SD and SC valves this is the only common port.) This port, called the alignment inlet in **Figure 3**, will be the designated inlet throughout this procedure.



#### **STUW**

Either common port can serve as the alignment inlet.

4. Put a nut (**Figure 2**) in the port corresponding to the last or highest numbered position.
  - For an electric actuator:** With the valve oriented as in **Figure 3**, the nut goes in the first port *above* the alignment inlet.
  - For an air actuator:** With the valve oriented as in **Figure 3**, the nut goes in the first port *below* the alignment inlet.

5. Locate the flow passage(s) perpendicular to the ring(s) that go around the seal. Note the pin which passes through the shaft. The end of the pin on the same side of the rotor as the flow passage(s) perpendicular to the ring(s) will be used as a pointer. (**Figure 3**)

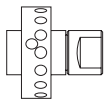

**STUW, SDUW, MW**

The pointer will be that end of the tab which is stamped with a letter denoting the rotor material. (**Figure 4**)

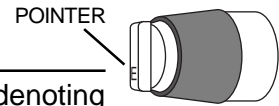

**Figure 4**

6. Insert the rotor in the valve body with the pointer centered on the nut, being careful not to touch the polished interior surface of the valve body with any of the metal parts of the rotor.
7. If the valve has external spring hardware, slide the three washers (in this sequence: 3/4" OD washer, teflon or polyimide washer, standard 1/2" OD stainless steel washer) over the 3/16" diameter threaded shaft while holding the rotor pressed firmly into the valve body. The flat side of the 3/4" back washer should rest on the rear collar of the valve. Next put the spring and the stainless hex nut in place. Tighten the nut 1/2 turn beyond the point where the spring touches the hardware at both ends, and butt the elastic lock nut against it.

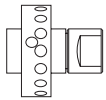

**STUW, SDUW, MW**

Screw the preload in fingertight.

8. **For an electric actuator:** Plug the actuator in. If the position indicator doesn't read "1", flip the switch to the HOME position.

**For an air actuator:** Determine that the actuator is in Position 1, but then if necessary override or disable the means of pulsing the air to the actuator so that pressure is continuously applied to the actuator port nearest the valve.

9. Place the valve on the actuator/standoff. Factory alignment places the common port(s) at 12 o'clock. Re-orienting the drive shaft on the square drive of the actuator allows three other possibilities.

**For a closemount valve:** Make sure that the pin in the rotor or driver is engaged by the slots of the coupling. Tighten the screw in the clamp ring enough to keep the valve from falling off, but make sure it's loose enough to allow the valve to be turned during the alignment procedure.

**For a valve on a standoff:** Make sure that the pin in the rotor or driver is engaged by the slots of the standoff drive shaft, and tighten the standoff clamp screw. Loosen the screw in the clamp ring which holds the standoff to the actuator enough to allow the valve/standoff assembly to be turned during the alignment procedure.

10. Establish a flow of clean gas (50 psi is adequate) into the alignment inlet.

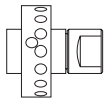

**STUW**

Establish gas flow into the common port at 6 o'clock (alignment inlet in **Figure 3**).

**NOTE:** When listening for flow in the following steps, it is helpful to isolate the sound by removing the fitting from the port under consideration. If all the fittings have been removed, install a loop connecting the two ports adjacent to the target port to better isolate the sound.

**CAUTION:**

Up to this point the instructions have applied to both air and electrically actuated valves. Because the two types of actuators rotate in opposite directions, it is necessary for the instructions to diverge at this point. For an *electrically* actuated valve, proceed with the steps immediately following. For an *air* actuated valve, look for the heading on the next page.

## For Electrically Actuated Valves

11. With the valve facing you and the actuator behind the valve, the port to the *left* of or counterclockwise from the alignment inlet corresponds to Position 1.

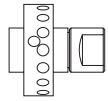

### STUW

With the common port at 6 o'clock as the inlet, the port to the *left* of or counterclockwise from the common port at 12 o'clock corresponds to Position 1.

If the assembly was done properly in Assembly Step 5, air will be coming out of the port to the *right* of the alignment inlet (or common port at 12 o'clock for STUW's). If so, proceed to Step 12. If the initial alignment was off a little, grip the valve and rotate it slightly in either direction (the actuator keeps the rotor fixed) until gas flows from this port. This sets up the "staging area" for the approach to Position 1.

12. Slowly rotate the valve clockwise until the first trace of flow is heard from the port of Position 1.
13. While holding the valve steady, use a soft pencil or ink marker to make a mark on the standoff corresponding to the slot in the actuator clamp ring. This slot makes a clear reference point for observing relative rotational positions. (**Figure 5**)
14. Continue the slow clockwise rotation of the valve body through the point of peak flow and on until the flow stops or is barely perceptible, as in Step 12.
15. Make another mark as in Step 13. (**Figure 5**)
16. Make a third pencil mark centered between the first two and rotate the valve counterclockwise until this midway mark is reached. (**Figure 5**)
17. While holding the valve steady, firmly tighten the screw in the clamp ring. The rotor should be properly positioned at the point of maximum flow when the actuator is stepped to the next position.

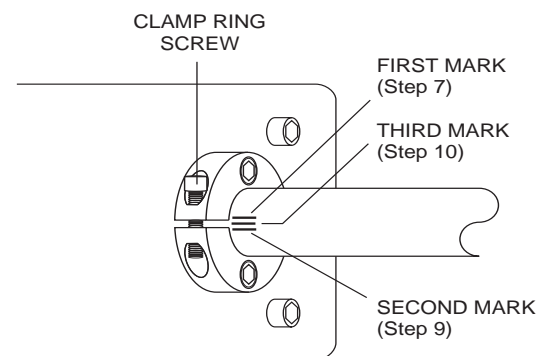
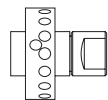

**Figure 5:** Marking the valve or standoff during the alignment procedure

It is a good idea to cycle the valve through all its positions to be certain everything is functioning properly. In some cases it is possible to do an additional alignment check by simply looking down the fitting detail and into the port as the valve is stepped from position to position. If it is a valve which has a relatively short distance from the bottom of the detail to the internal taper, the engraved "dimples" on the seal are visible as they come into alignment with the port.

## For Air Actuated Valves

11. With the valve facing you and the actuator behind the valve, the port to the *right* of or clockwise from the alignment inlet corresponds to Position 1.



### STUW

With the common port at 6 o'clock as the inlet, the port to the *right* of or clockwise from the common port at 12 o'clock corresponds to Position 1.

If the assembly was done properly in Assembly Step 5, air will be coming out of the port to the *left* of the alignment inlet (or common port at 12 o'clock for STUW's). If so, proceed to Step 12. If it is not, grip the valve and rotate it counterclockwise until gas flows from this port. Depending on which way the initial alignment was off, this will take either a very slight rotation or nearly a full revolution. (Even though flow might have been achieved by a slight clockwise rotation, the air actuator will not keep the rotor fixed against a force in that direction.) This sets up the "staging area" for the approach to Position 1.

12. Grip the valve and slowly rotate it counterclockwise until the first traces of flow are heard from the port of Position 1.
13. While holding the valve steady, use a soft pencil or ink marker to make a mark on the standoff corresponding to the slot in the actuator clamp ring. This slot makes a clear fixed reference point for observing relative rotational positions. (**Figure 6**)
14. Continue the slow counterclockwise rotation of the valve body through the point of peak flow and on until the flow stops or is barely perceptible, as in Step 12.
15. Make another mark as in Step 13. (**Figure 6**)
16. Make a third pencil mark centered between the first two and rotate the valve clockwise until this midway mark is reached. (**Figure 6**)
17. While holding the valve steady, firmly tighten the screw in the clamp ring. The rotor should be properly positioned at the point of maximum flow when the actuator is stepped to the next position.

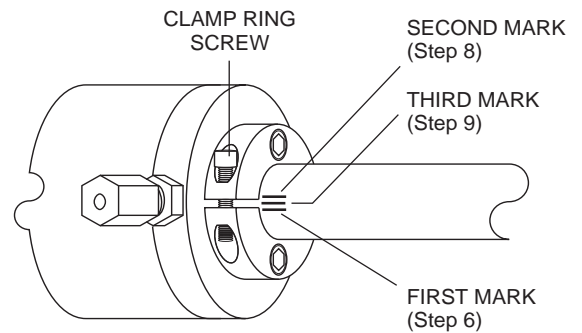
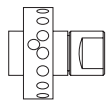

**Figure 6:** Marking the valve or standoff during the alignment procedure

It is a good idea to cycle the valve through all its positions to be certain everything is functioning properly. In some cases it is possible to do an additional alignment check by simply looking down the fitting detail and into the port as the valve is stepped from position to position. If it is a valve which has a relatively short distance from the bottom of the detail to the internal taper, the engraved “dimples” on the seal are visible as they come into alignment with the port.

## Leak Detection

The instructions above put a minimum amount of tension on the spring to facilitate the manual adjustments required in the alignment procedure. Before proceeding with this section, add an additional full turn to the hex nuts on the rotor shaft and cycle the valve through a complete revolution.



### **STUW, SDUW, MW**

Use a wrench to tighten the preload assembly until the threads bottom out.

1. The valve should be tested with a gas leak detector. If a leak detector is unavailable, an alternative is to pressurize the valve with an appropriate gas and immerse it in a solvent with low surface tension, e.g. 2-propanol. Be careful to test for gross leaks before immersing the valve.

### **Wear eye protection.**

2. If the valve leaks, tighten the nuts in 1/4 turn increments, cycling the valve through a complete revolution between each 1/4 turn of tension, until the leaking stops. Test after each additional 1/4 turn. Never tighten the spring to the point where its windings touch one another.

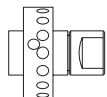

### **STUW, SDUW, MW**

If the valve leaks, tighten the socket adjustment screw (see **Figure 1**) in increments of approximately 1/16 turn, cycling the valve through a complete revolution between each increment. Test after each additional 1/16 turn.

If additional help is needed, consult the factory or check out the support section of [www.vici.com](http://www.vici.com).