

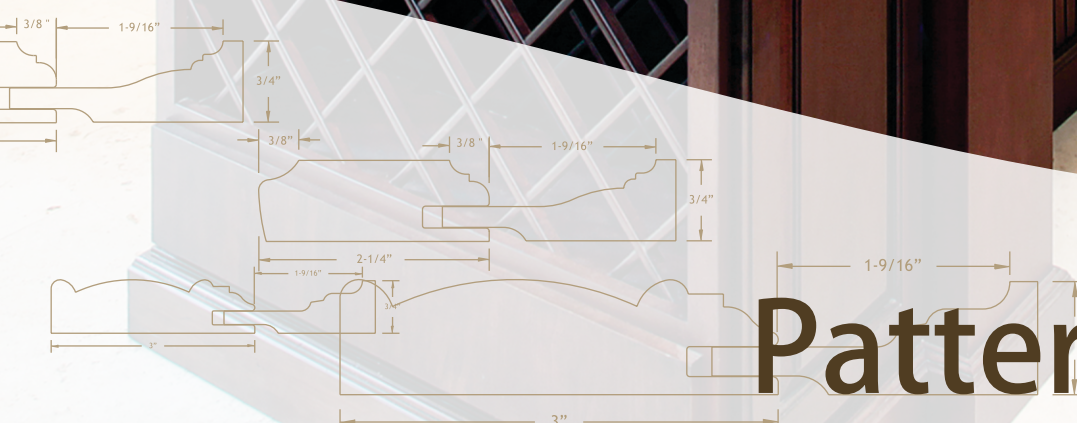

**cabdoor**

“Where Custom Is Standard”



# Patterns Guide



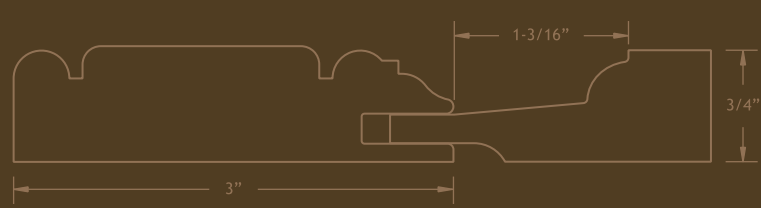
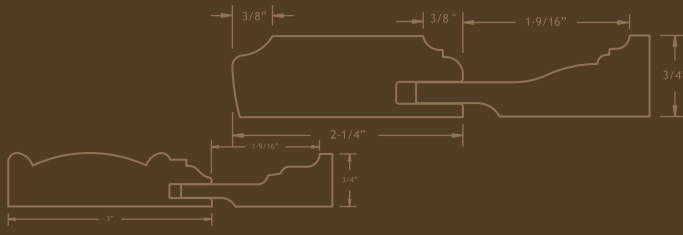

## Profiles and Pattern Groupings

Through-out this guide, you will see every profile and pattern labeled with a Usage Group Letter and assigned a color. These properties will allow you to match Patterns and Profiles successfully.

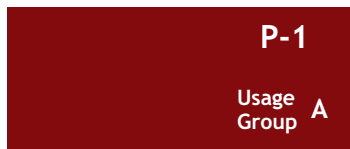

In this example, the P-1 Profile is part of Usage Group A. Any Panel that is part of Usage Group A will fit correctly into the P-1 Profile.

The color assigned to Usage Group A will remain the same throughout the guide, allowing quick visibility to those panels or patterns needed to fit your requirements.



Some Panel Profiles are listed as “Available in Flat Back” and are designed to fit into Mitre Profiles that share the same color of Orange.

These panels are finish sanded prior to assembly as required by the Mitre Pattern chosen.

Again, utilize the color scheme to quickly identify which Mitre Profiles require the Flat Back panel configuration.

### Call us if you need help...

In the event you would like help understanding the approach taken in this Guide, please contact Customer Service and they will be glad to help you determine what to order to meet the requirements of your project.

# How to Use This Guide

## Quick View of Contents

Inside Profiles . . . . .	pg 2
Applied Moulding Profiles . . . . .	pg 10
3” Mitre Patterns . . . . .	pg 12
2-1/4” Mitre Patterns. . . . .	pg 16
Panel Profiles . . . . .	pg 20
Applied Moulding Panel Profiles. . .	pg 28
Reverse Raised Panel Profiles . . .	pg 32
Edge Details . . . . .	pg 34

## Common Terminology and Phrases used in this guide:

**The Arch Symbol:**  
Denotes that all arch styles are available for this profile.



**The Glazing Symbol:**  
This Symbol denotes that the pattern or profile is suitable for glazing. Glazing can almost always be done between the frame and panel.



**Standard Lites:**  
All Lite styles requiring no special jiggling, such as curves and angles.

**Deluxe Lites:** All Lite styles requiring custom jiggling for curves and angles... see PureWood™ catalog.

**Glass sizing:** For Lite and Glass door profiles, glass sizing is the constant value you add to the inside frame dimensions of your glass door. The constant value allows 1/16” clearance for inserting the glass.

**Minimum Panel Width:**  
This refers to the minimum amount of panel that can be revealed between the frame parts, and still maintain at least 3/4” of flat face on the panel for hardware (if needed).

To find your minimum door size using the panel selected, add your part widths to the Minimum Panel Width.

## To Contact Customer Care:

Monday - Thursday 8:00 am until 5:00 pm  
 Friday 8:00 am until 3:30 pm  
 Toll Free- (800) 800-9382  
 Phone- (503) 363-6367  
 By Fax: (503) 363-6510  
 By Traditional Email: sales@cabdoor.com

## Standard Profile

## Glass Profile

## Mullion Profile

P-1

Usage Group A

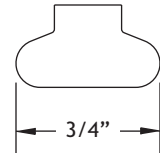
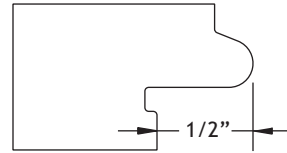
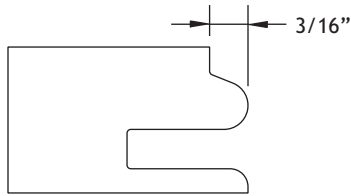

- Notes:**
- Available at 2-1/4" frame width with no upcharge.
  - Arches- Available for all Arch styles.

- Lites- Available for all Standard and Deluxe lite styles.
- Glass size = Inside Frame - 15/16".
- Not normally used for opaque painting

P-2

GZ Usage Group A

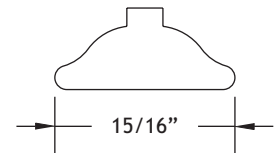
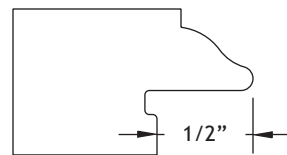
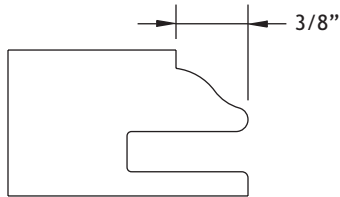

- Notes:**
- Available at 2-1/4" frame width with no upcharge.
  - Arches- Available for all Arch styles

- Lites- Available for all Standard and Deluxe lite styles.
- Glass size = Inside Frame + 15/16".
- Good for Glazed finishes.

P-10

Usage Group A

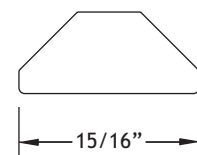
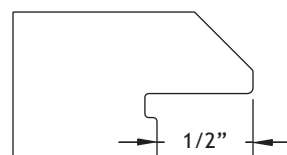
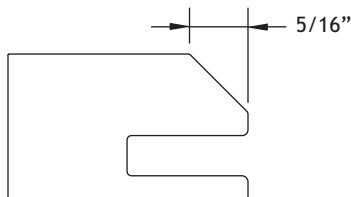

- Notes:**
- Available at 2-1/4" frame width with no upcharge.
  - Arches- Available for all Arch styles.

- Lites- Available for all Standard and Deluxe lite styles.
- Glass size = Inside Frame + 15/16".

P-11

GZ Usage Group A

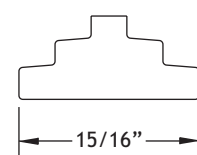
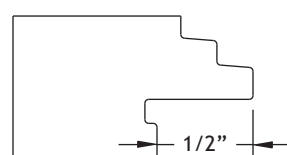
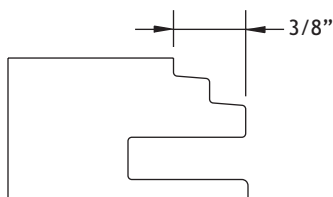

- Notes:**
- Available at 2-1/4" frame width with no upcharge.
  - Arches- No Arch Styles available

- Lites- Available for all Standard lite styles
- Glass size = Inside Frame + 15/16"

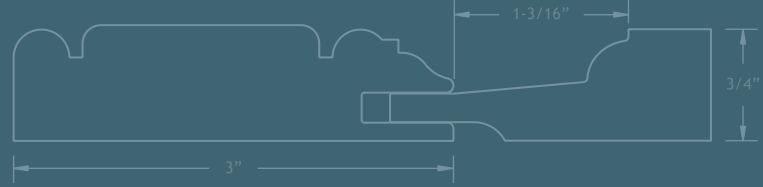
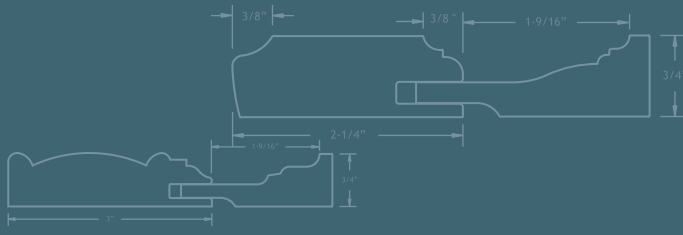

# Cope & Pattern Profiles

P-13

GZ Usage Group A

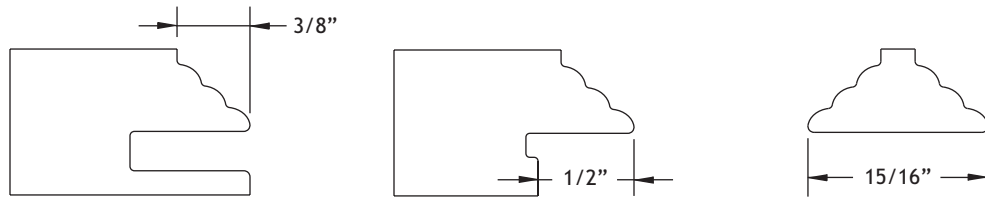

- Notes:**
- Available at 2-1/4" frame width with no upcharge.
  - Arches- Available for all Arch styles.
  - Lites- Available for all Standard and Deluxe lite styles.
  - Glass size = Inside Frame + 15/16".

P-15

GZ Usage Group A

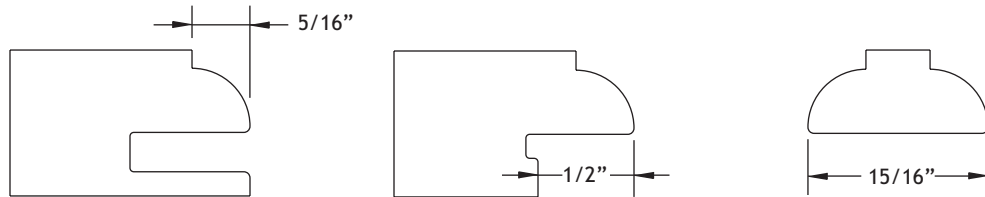

- Notes:**
- Available at 2-1/4" frame width with no upcharge.
  - Arches- Available for all Arch styles.
  - Lites- Available for all Standard and Deluxe lite styles.
  - Glass size = Inside Frame + 15/16".

P-18

GZ Usage Group A

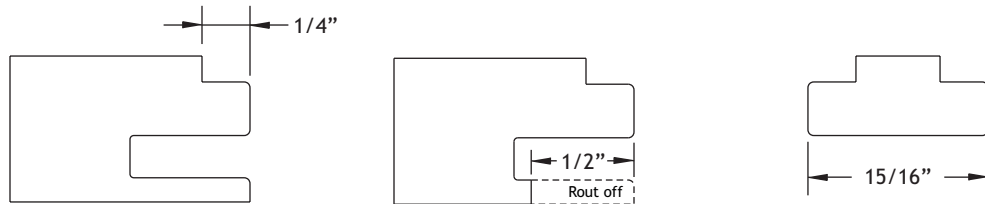

- Notes:**
- Available at 2-1/4" frame width with no upcharge.
  - Arches- No Arch styles available.
  - Lites- Available for all Standard lite styles only.
  - Glass size = Inside Frame + 15/16".

P-23

GZ Usage Group A

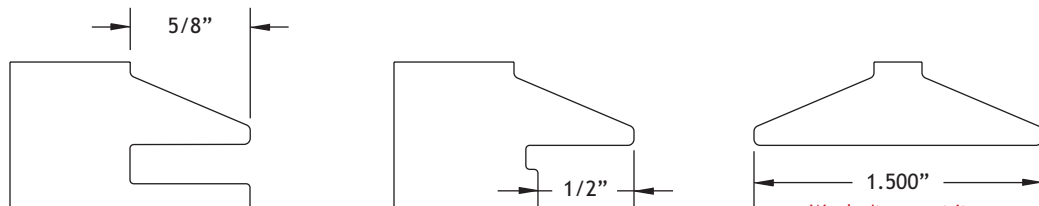

- Notes:**
- Available at 2-1/4" frame width with no upcharge.
  - Arches- Available for all Arch styles.
  - Lites- Available for all Standard Lite styles only, but due to width, suggest it on very large doors only.
  - Glass size = Inside Frame + 15/16".
- We don't suggest it...

## Standard Profile

## Glass Profile

## Mullion Profile

**P-28**  
**GZ** Usage Group A

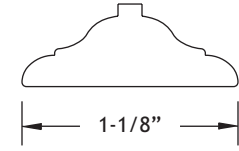
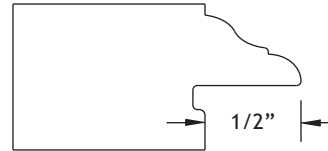
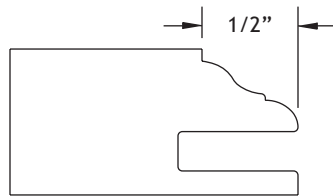

- Notes:**
- Available at 2-1/4" frame width with no upcharge.
  - Arches- Available for all Arch styles.

- Lites- Available for all Standard and Deluxe Lite styles.
- Glass sizing = Inside Frame + 15/16".

**P-35**

Usage Group F

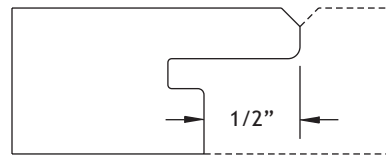
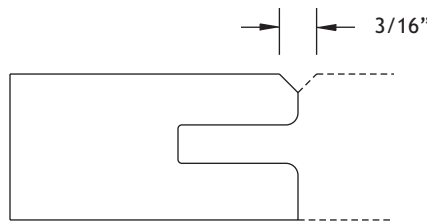

- Notes:**
- Available at 2-1/4" frame width with no upcharge.
  - Arches- No Arch styles available.

- Lites- No Lite Styles available.
- Glass sizing = Inside Frame + 15/16".

**P-36**

Usage Group G

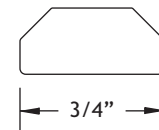
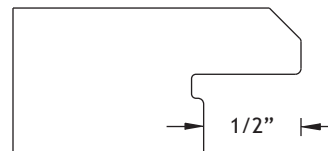
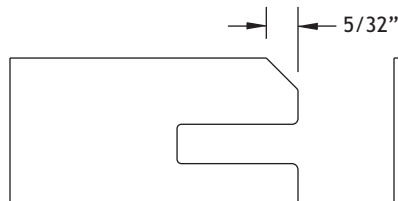

- Notes:**
- Available at 2-1/4" frame width with no upcharge.
  - Arches- No Arch Styles available.

- Lites- Available for all Standard Lite styles only.
- Glass size = Inside Frame + 15/16".

**P-37**

Usage Group A

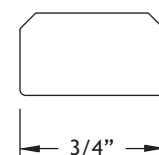
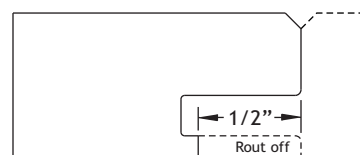
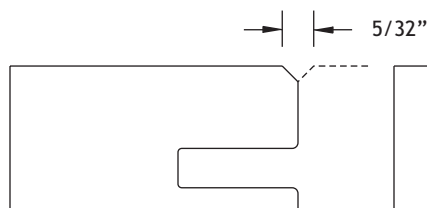

- Notes:**
- Available at 2-1/4" frame width with no upcharge.
  - Arches- No Arch Styles available.

- Lites- Available for all Standard Lite Styles only.
- Glass size = Inside Frame + 15/16".

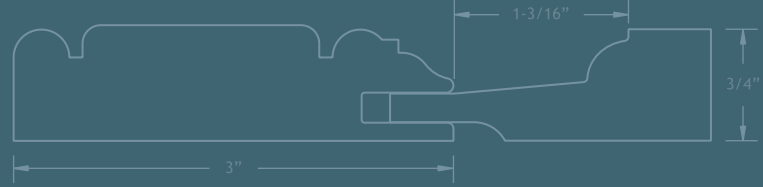
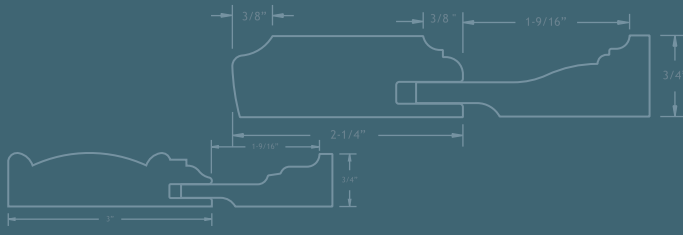

# Cope & Pattern Profiles

P-38

Usage Group B

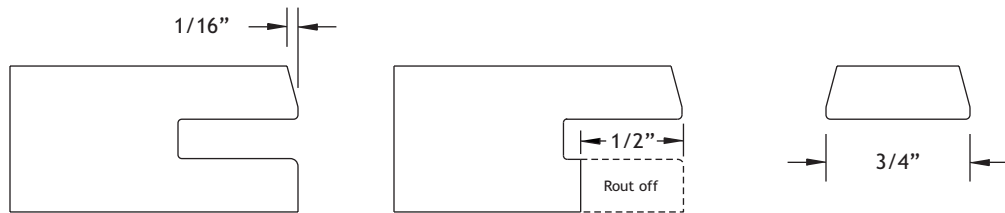

- Notes:**
- Available at 2-1/4" frame width with no upcharge.
  - Arches- No Arch styles available.
  - Lites- Available for all Standard lite styles only.
  - Glass sizing = Inside Frame + 15/16".

P-39

Usage Group A

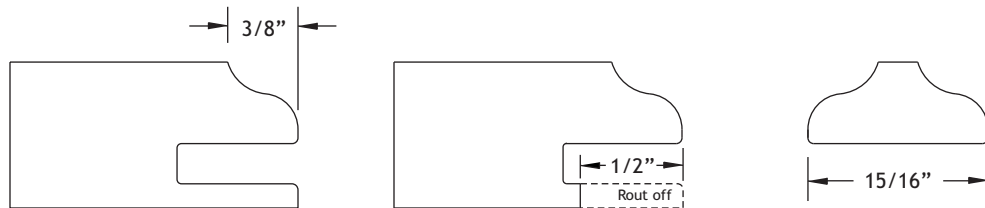

- Notes:**
- Available at 2-1/4" frame width with no upcharge.
  - Arches- Available for all Arch Styles
  - Lites- Available for all Standard and Deluxe Lite styles.
  - Glass sizing = Inside Frame + 15/16".

P-40

GZ Usage Group A

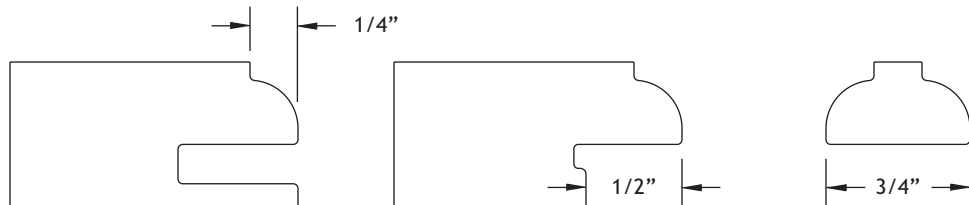

- Notes:**
- Available at 2-1/4" frame width with no upcharge.
  - Arches- Available for all Arch styles
  - Lites- Available for all Standard Lite styles only.
  - Glass size = Inside Frame + 15/16".

P-45

Usage Group G

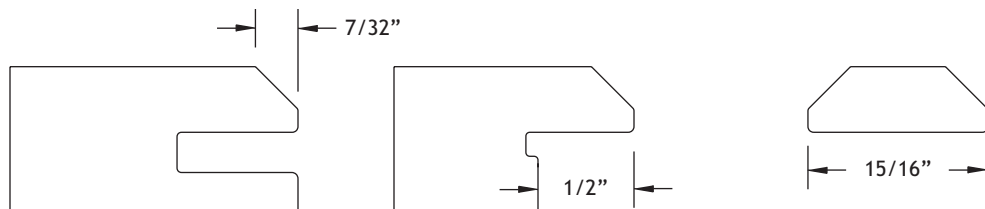

- Notes:**
- Available at 2-1/4" frame width with no upcharge.
  - Arches- Available for all Arch styles.
  - Lites- Available for all Standard Lite styles only.
  - Glass size = Inside Frame + 15/16".

## Standard Profile

## Glass Profile

## Mullion Profile

**GZ** P-47  
Usage Group A

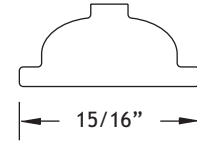
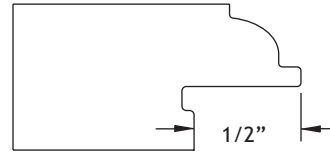
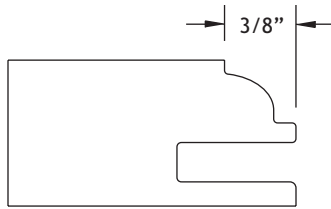

- Notes:**
- Available at 2-1/4" frame width with no upcharge.
  - Arches- Available for all Arch styles.

- Lites- Available for all Standard Lite styles only.
- Glass sizing = Inside Frame + 15/16".

**GZ** P-49  
Usage Group A

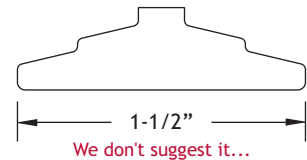
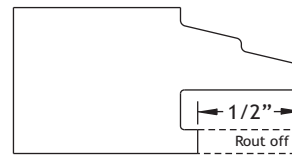
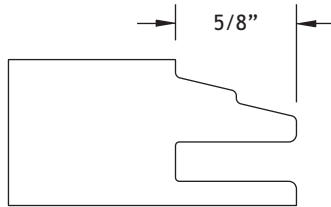

- Notes:**
- Available at 2-1/4" frame width with no upcharge.
  - Arches- No Arch Styles available.

- Lites- Available for all Standard Lite styles only, but due to width, suggest it on very large doors only.
- Glass size = Inside Frame + 15/16".

**GZ** P-50  
Usage Group A

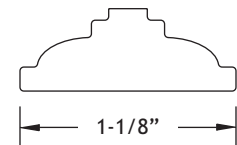
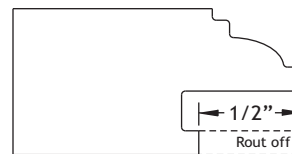
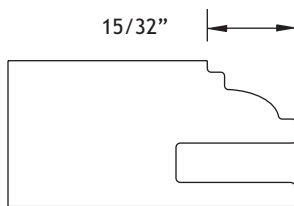

- Notes:**
- Available at 2-1/4" frame width with no upcharge.
  - Arches- Available for all Arch Styles.

- Lites- Available for all Standard lite styles
- Glass size = Inside Frame + 15/16".
- Great for Glazed Finishes.

**GZ** P-51  
Usage Group A

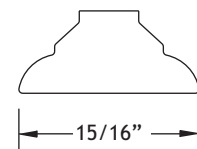
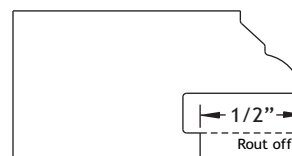
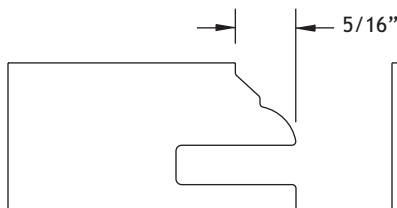

- Notes:**
- Available at 2-1/4" frame width with no upcharge.
  - Arches- Available for all Arch Styles.

- Lites- Available with Standard Lite styles only.
- Glass size = Inside Frame + 15/16".



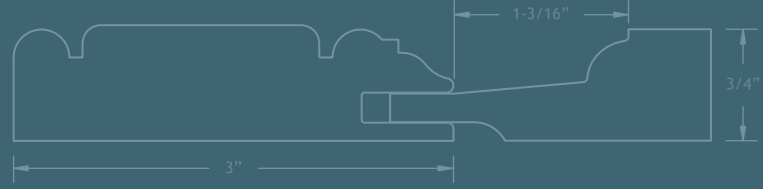
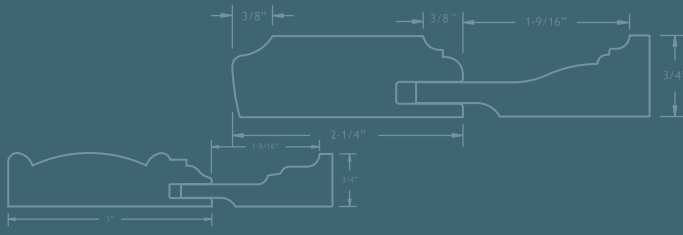

# Cope & Pattern Profiles

**P-53**

Usage Group H

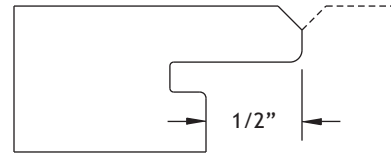
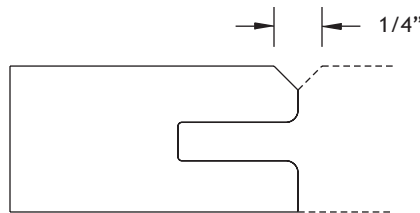

- Notes:**
- Available at 2-1/4" frame width with no upcharge.
  - Arches- No Arch Styles available.

- Lites- no Lite Styles available.
- Glass sizing = Inside Frame + 15/16".

**P-57**

**GZ** Usage Group A

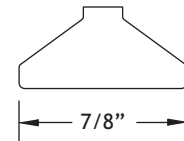
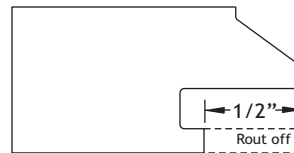
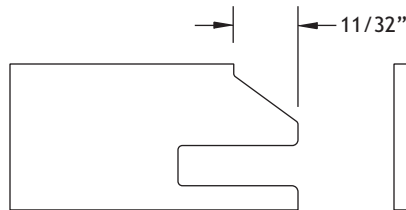

- Notes:**
- Available at 2-1/4" frame width with no upcharge.
  - Arches- Available for all Arch Styles.

- Lites- Available for all Standard Lite styles only.
- Glass size = Inside Frame + 15/16"

**P-59**

**GZ** Usage Group A

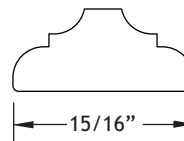
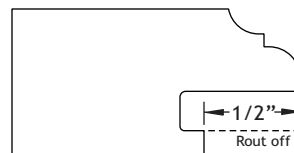
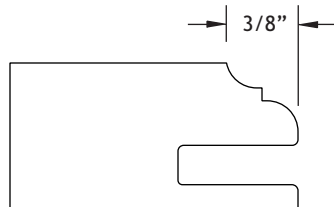

- Notes:**
- Available at 2-1/4" frame width with no upcharge.
  - Arches- Available for all Arch Styles.

- Lites- Available for all Standard Lite styles only.
- Glass size = Inside Frame + 15/16"

**P-65**

Usage Group A

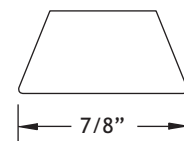
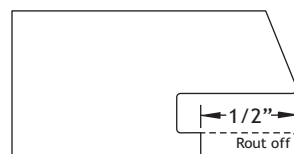
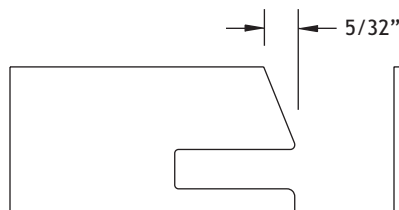

- Notes:**
- Available at 2-1/4" frame width with no upcharge.
  - Arches- No Arch Styles available.

- Lites- Available for all Standard Lite styles only.
- Glass size = Inside Frame + 15/16"

## Standard Profile

## Glass Profile

## Mullion Profile

**P-67**  
**GZ** Usage Group A

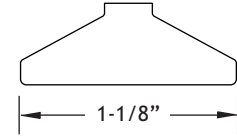
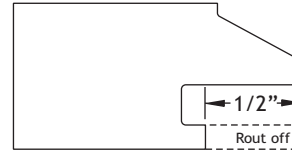
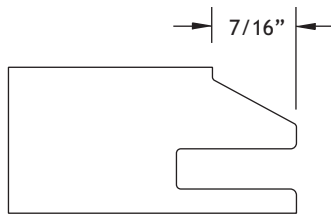

- Notes:**
- Available at 2-1/4" frame width with no upcharge.
  - Arches- Available for all Arch styles.

- Lites- Available for all Standard Lite styles only.
- Glass sizing = Inside Frame + 15/16".

**P-68**

Usage Group A

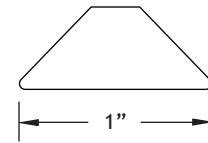
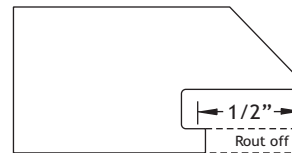
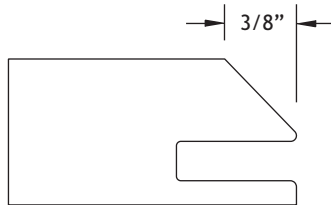

- Notes:**
- Available at 2-1/4" frame width with no upcharge.
  - Arches- No Arch Styles available.

- Lites- Available for all Standard Lite styles only.
- Glass size = Inside Frame + 15/16".

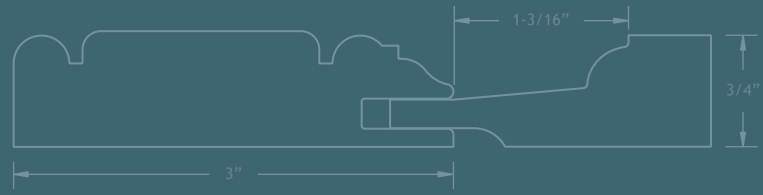
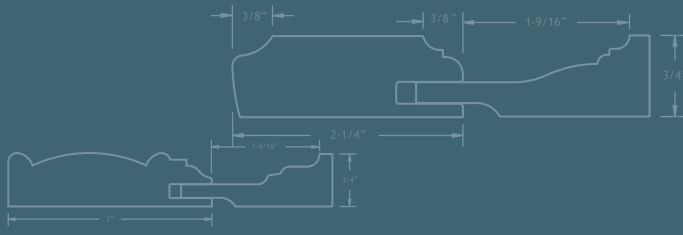

# Cope & Pattern Profiles

P-3

Usage Group B

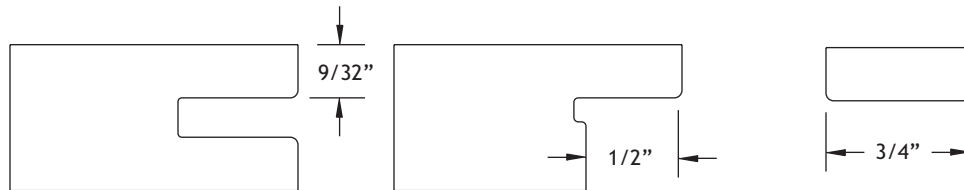

- Notes:**
- Available at 2-1/4" frame width with no upcharge.
  - Arches- Available for all Arch styles
  - Lites- Available for all Standard and Deluxe lite styles
  - Not normally used for opaque painting

P-14

Usage Group D

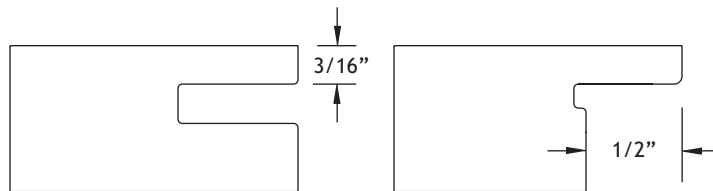

- Notes:**
- Available at 2-1/4" frame width with no upcharge.
  - Arches- Available for all Arch styles
  - Lites- Available for all Standard and Deluxe lite styles
  - Great for Glazed finishes
  - Glass size = Inside Frame + 15/16"

P-19

Usage Group E

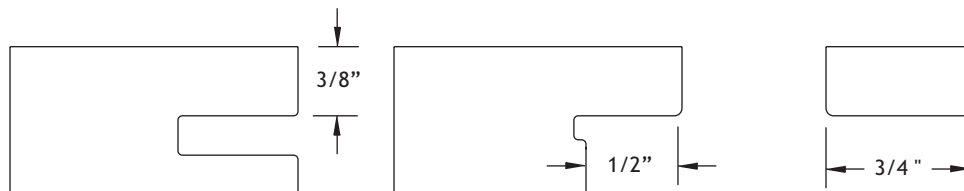

- Notes:**
- Available at 2-1/4" frame width with no upcharge.
  - Arches- No Arch Styles available
  - Lites- Available for all Standard lite styles
  - Glass size = Inside Frame + 15/16"

P-20

Usage Group A



- Notes:**
- Available at 2-1/4" frame width with no upcharge.
  - Arches- No Arch Styles available
  - Lites- Available for all Standard lite styles
  - Glass size = Inside Frame + 15/16"

Usage  
Group A

**Group "A"  
Panels Available  
for Applied Mouldings:**

- Standard Inset Panel
- Pnl-09
- Pnl-15
- Pnl-18 (AMP-02 only)
- Pnl-19 (AMP-02 only)
- Pnl-51
- Pnl-62
- Pnl-90
- All Beaded and V-Grooved panels of Group "A".

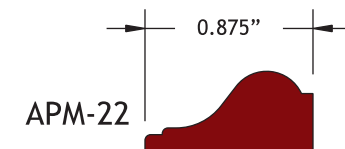
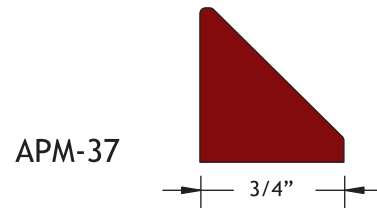
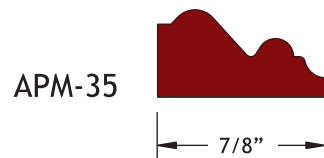
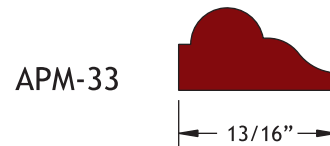
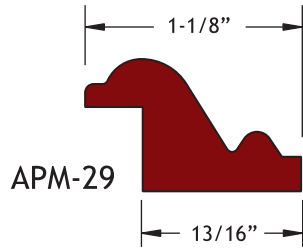
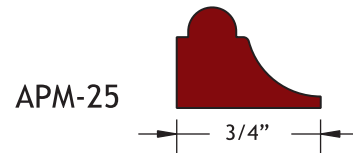
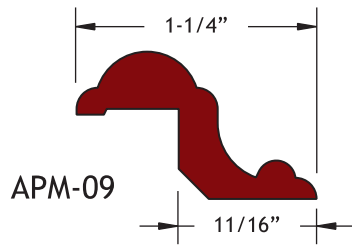
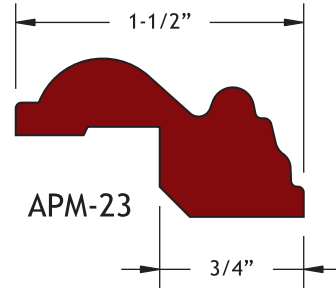
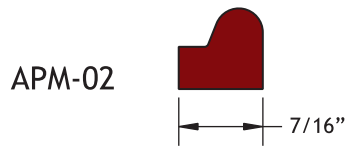

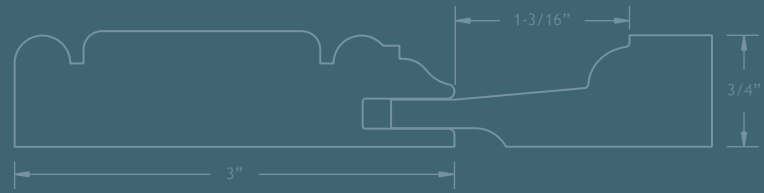
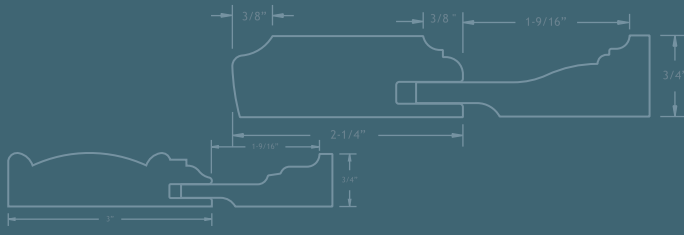

# Applied Moulding Profiles

Usage  
Group B

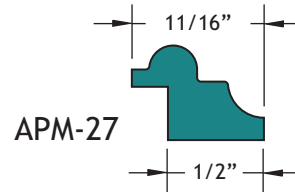
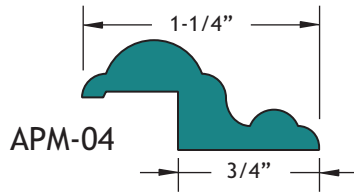
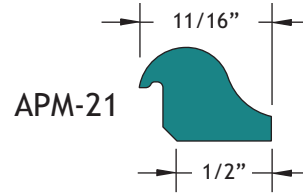
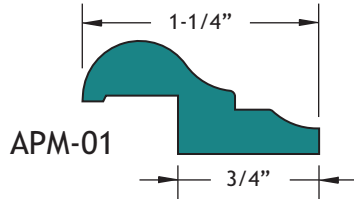

## Group "B" Panels Available for Applied Mouldings:

- Standard Inset
- Pnl-04
- Pnl-15
- Pnl-79
- All Beaded and V-Grooved panels of Group "B"

Usage  
Group E

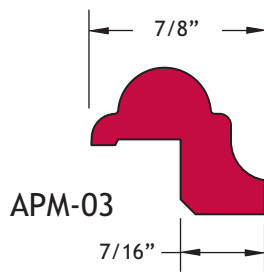

## Group "E" Panels Available for Applied Mouldings:

- Standard Inset
- Pnl-09 (back is recessed)
- Pnl-27 (APM-03 only)
- Pnl-33 (APM-03 only)
- Pnl-74
- All Beaded and V-Grooved panels of Group "A" (although panel will be recessed from the back).

Lexington  
**MP-01**  
 Usage Group A

**GZ**

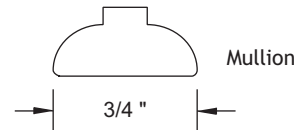
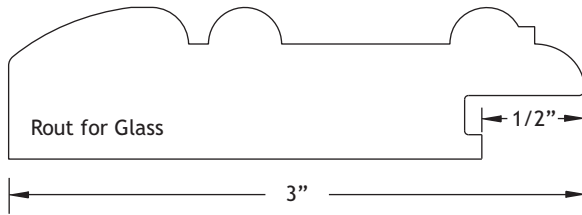
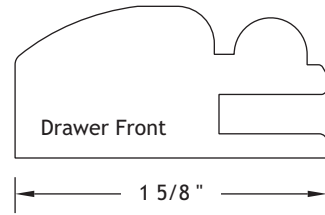
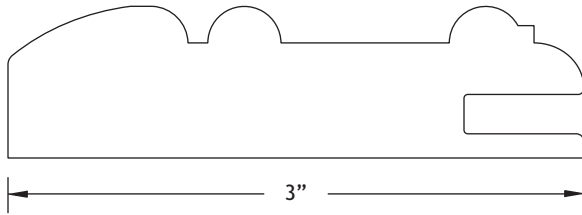

- Notes:**
- Order panels from Graph A as Flat Backs.
  - Glass size = Inside Frame + 15/16"
  - Lites- Available for all Standard and Deluxe lite styles.
  - Double panel doors and multi-panel bar backs are available.

Concord  
**MP-02**  
 Usage Group A

**GZ**

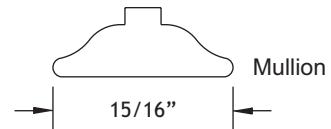
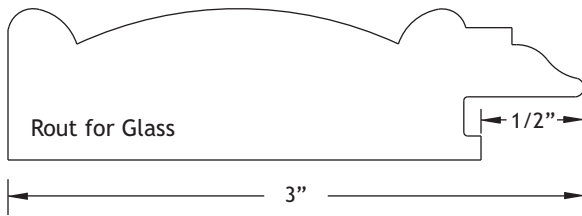
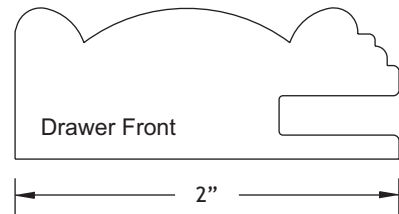
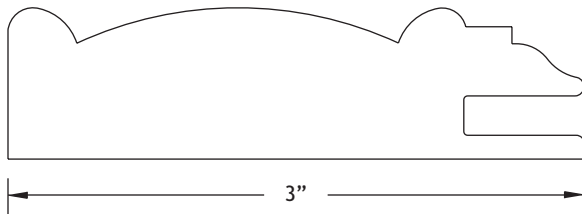

- Notes:**
- Lites- Available for all Standard and Deluxe lite styles
  - Glass size = Inside Frame + 15/16"

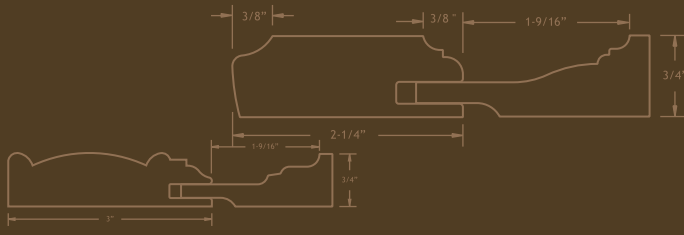

## 3" Mitre Profiles

Somersville

**MP-06**

Usage Group **A**

**GZ**

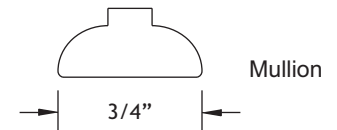
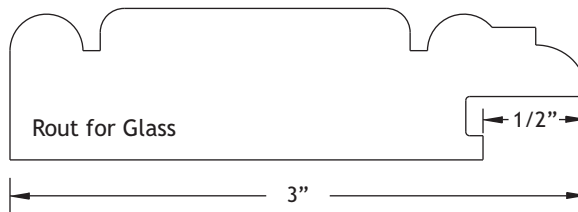
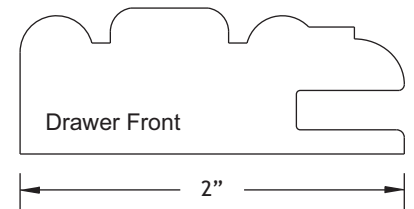
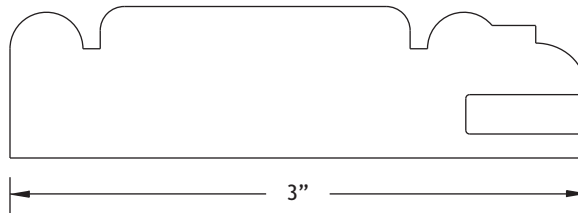

- Notes:**
- Order panels from Graph A as Flat Backs.
  - Lites- Available for all Standard and Deluxe lite styles.
  - Glass size = Inside Frame + 15/16"
  - Double panel doors and multi-panel bar backs are available.

Revere

**MP-09**

Usage Group **A**

**GZ**

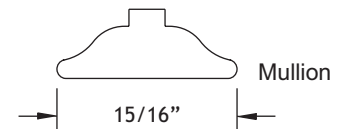
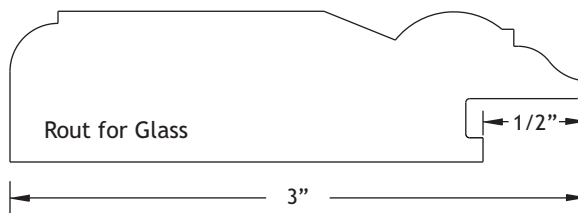
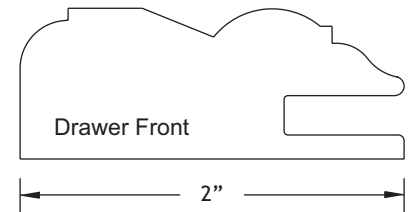
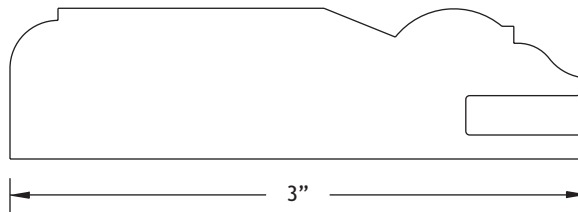

- Notes:**
- Lites- Available for all Standard and Deluxe lite styles
  - Glass size = Inside Frame + 15/16"

Georgetown

**MP-11**

Usage Group A

**GZ**

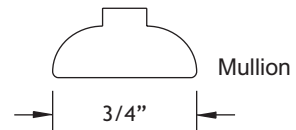
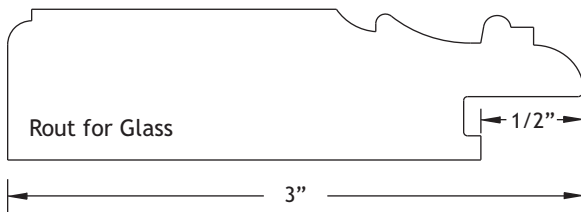
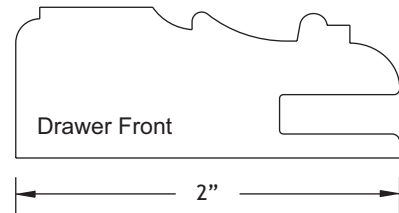
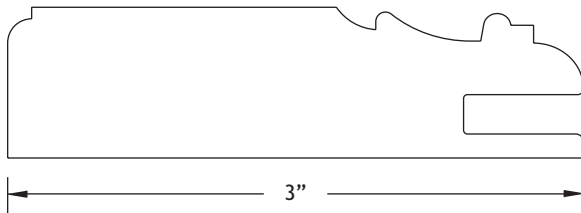

- Notes:**
- Order panels from Graph A as Flat Backs.
  - Glass size = Inside Frame + 15/16"
  - Lites- Available for all Standard and Deluxe lite styles.
  - Double panel doors and multi-panel bar backs are available.

Cambridge

**MP-12**

Usage Group A

**GZ**

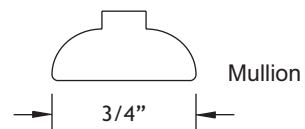
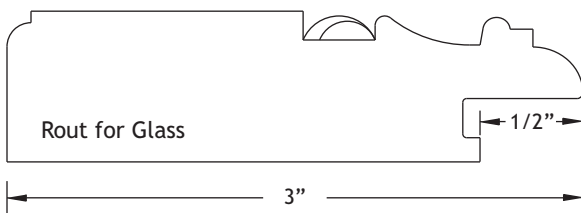
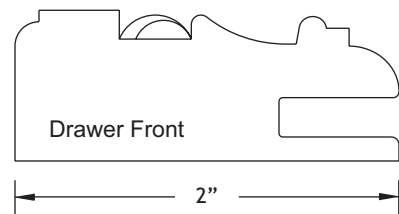
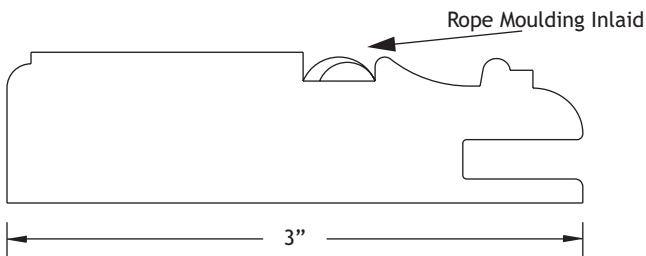

- Notes:**
- Lites- Available for all Standard and Deluxe lite styles
  - Glass size = Inside Frame + 15/16"



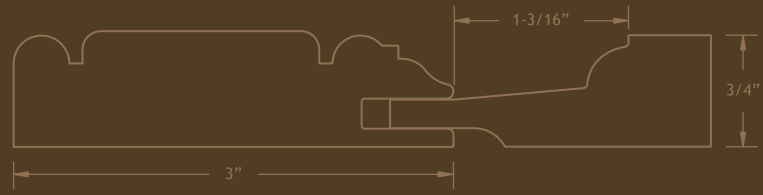
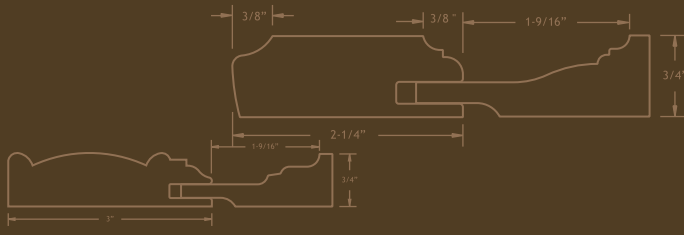

## 3" Mitre Profiles

Cherry Hill

MP-27

Usage  
Group A

GZ

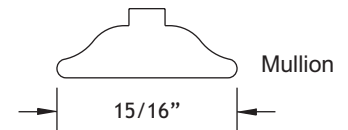
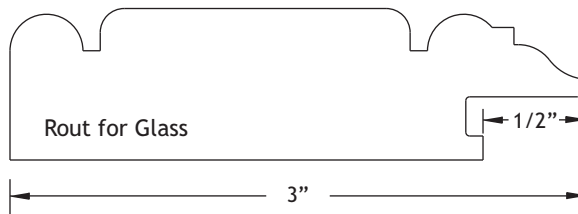
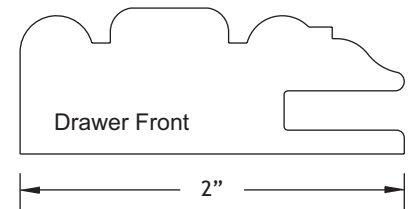
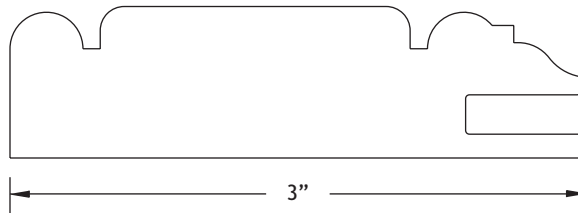

- Notes:**
- Order panels from Graph A as Flat Backs.
  - Lites- Available for all Standard and Deluxe lite styles.
  - Glass size = Inside Frame + 15/16"
  - Double panel doors and multi-panel bar backs are available.

Petersburg

MP-3

Usage Group A

GZ

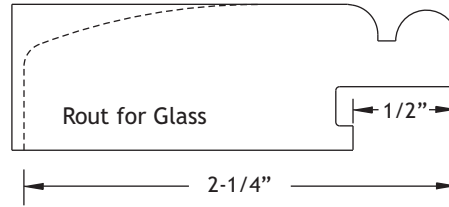
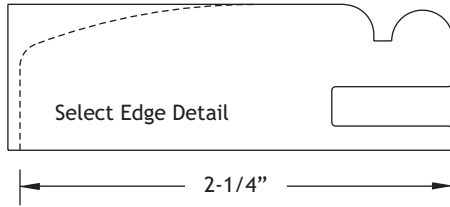

**Notes:**

- Select the desired Edge Detail from pages 30-32 of this Guide. Default Edge will be E-32.

- Lites- No Lite Styles available.
- Glass size = Inside Frame + 15/16".

Chesapeake

MP-5

Usage Group A

GZ

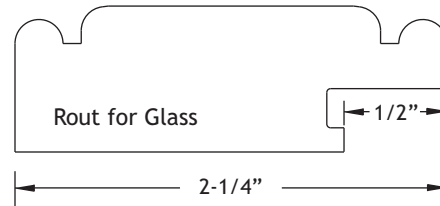
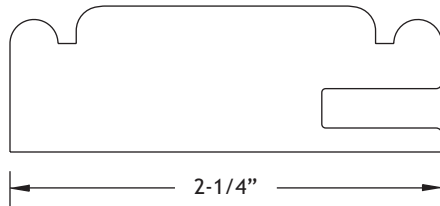

**Notes:**

- Lites- No Lite Styles available.
- Glass size = Inside Frame + 15/16".

Wheatland

MP-21

Usage Group A

GZ

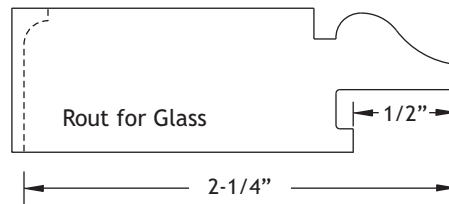
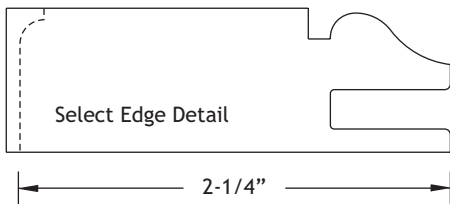

**Notes:**

- Select the desired Edge Detail from pages 30-32 of this Guide. Default Edge will be E-46.

- Lites- No Lite Styles available.
- Glass size = Inside Frame + 15/16".

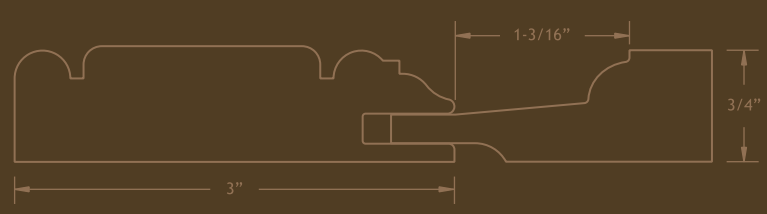
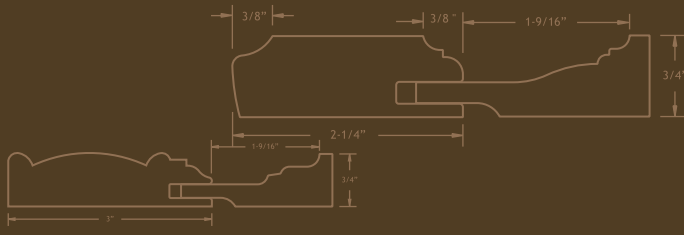

## 2-1/4" Mitre Profiles

Williamsburg

MP-4

Usage Group A

GZ

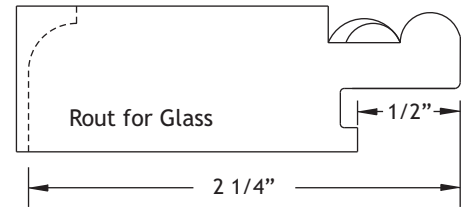
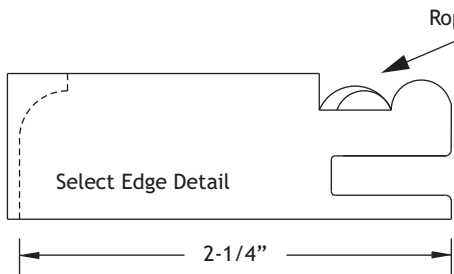

**Notes:**

- Select the desired Edge Detail from pages 30-32 of this Guide. Default Edge will be E-42.

- Lites- No Lite Styles available.
- Glass size = Inside Frame + 15/16".

Chantilly

MP-20

Usage Group A

GZ

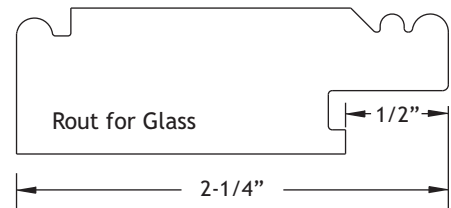
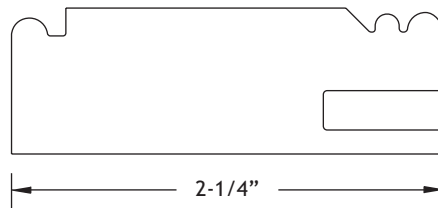

**Notes:**

- Lites- No Lite Styles available.
- Glass size = Inside Frame + 15/16".

MP-34

Usage Group A

GZ

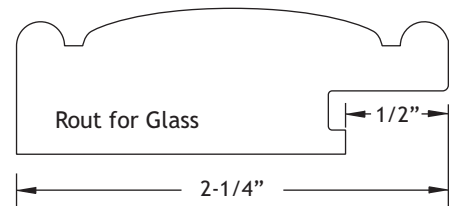
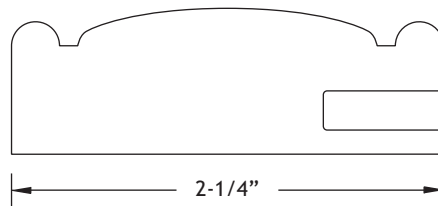

**Notes:**

- Lites- No Lite Styles available.
- Glass size = Inside Frame + 15/16".

Hartford  
MP-7P-X  
Usage Group A

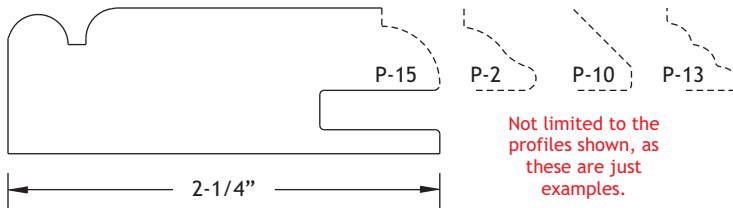

Not limited to the profiles shown, as these are just examples.

Select any Group "A" Inside Profile and apply to this Mitre Pattern to create the famed "Rosewood Edge".

To Order, replace the "X" with the Cope and Pattern profile number desired.

For example, to order with a P-15 Inside Profile, call-out MP-7P-15 when ordering.

GZ

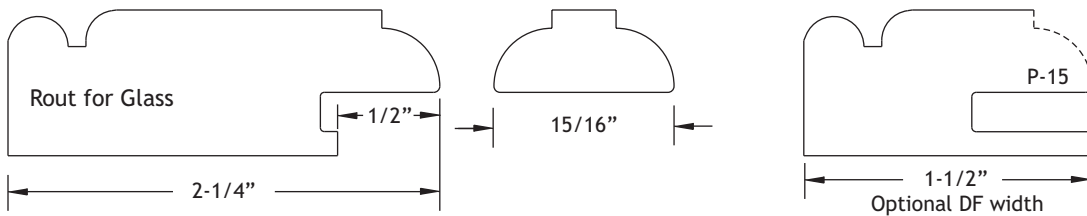

- Notes:**
- Available in 2-1/4", 2-1/2" and 3" widths with no upcharge.
  - Lites- Available for all Standard and Deluxe lite styles based on the Profile specifications earlier in this guide.

- Glass size = Inside Frame + 15/16"
- Drawer Front is typically 2-1/4" but you may specify 1-1/2" width, if required.
- Great for Glazed finishes.

## 2-1/2" Mitre Profile

Brookhaven  
MP-19  
Usage Group A

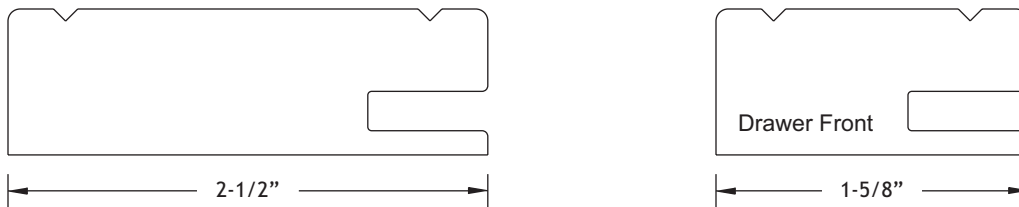

GZ

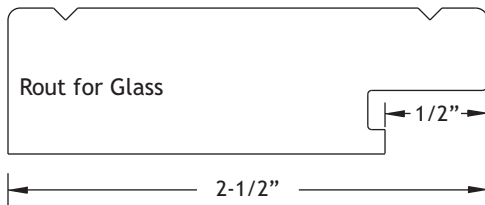

- Notes:**
- Lites- No Lite Styles available
  - Glass size = Inside Frame + 15/16"

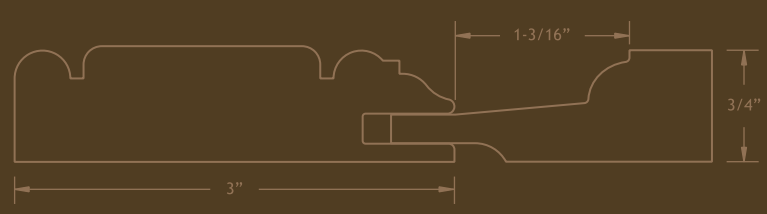
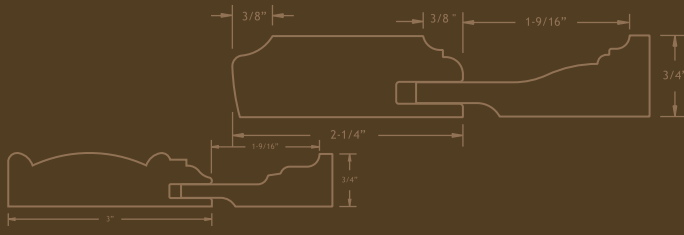

## Other Mitre Profiles

Alexandria  
**MP-26**  
 Usage Group A

2-1/2" Mitre Profile  
**GZ**

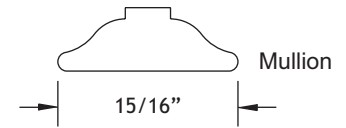
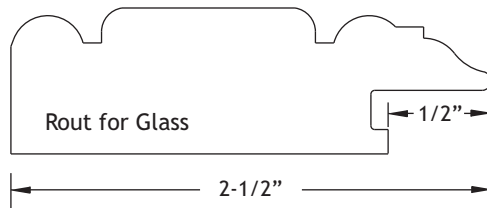
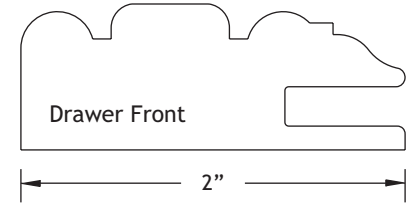
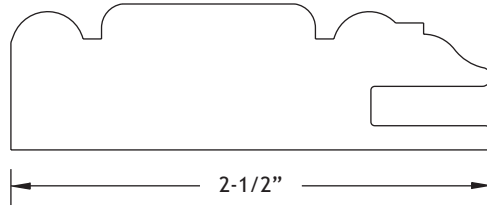

**Notes:** • Lites- Available for all Standard and Deluxe lite styles

• Glass size = Inside Frame + 15/16"

**MP-56**  
 Usage Group A

2-1/2" Mitre Profile  
**GZ**

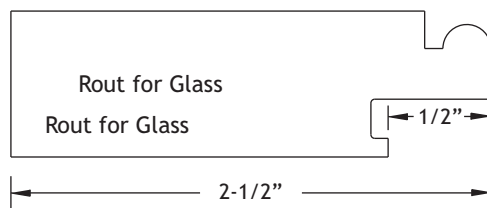
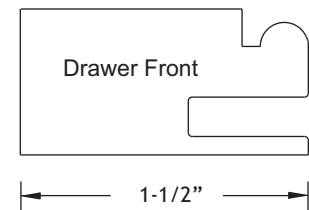
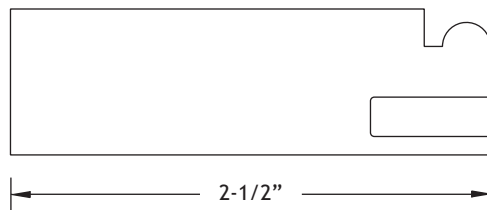

**Notes:** • Lites- No Lite Styles available.  
 • Available in 2-1/4", 2-1/2" and 3" widths with no upcharge.

• Glass size = Inside Frame + 15/16"  
 • Drawer Front is typically a 1-1/2" wide pattern, but you may specify any standard size required.

## Solid Panel Profile

## MDF Panel Profile

**Pnl-01**

Usage Group **A**

Available in Flat Back

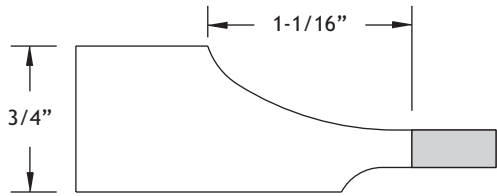

Minimum Panel Width = 2-7/8"

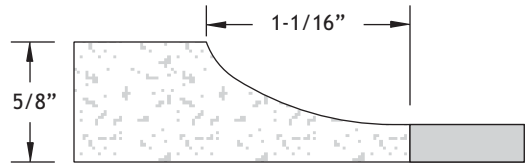

**Pnl-02**

Usage Group **A**

Available in Flat Back

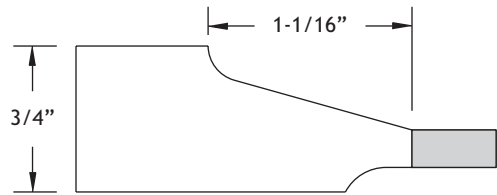

Minimum Panel Width = 2-7/8"

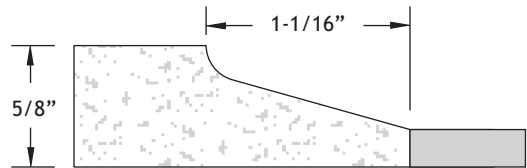

**Pnl-03**

Usage Group **A**

Available in Flat Back

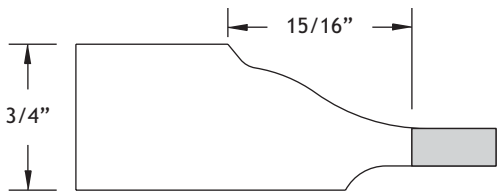

Minimum Panel Width = 2-7/8"

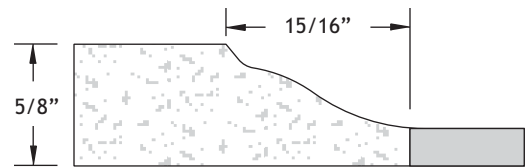

**Pnl-04**

Usage Group **B**

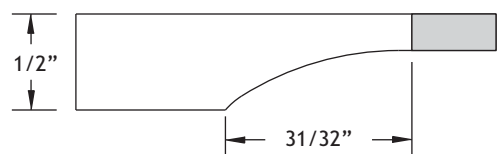

Minimum Panel Width = 1-1/2"

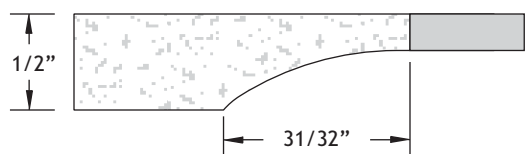

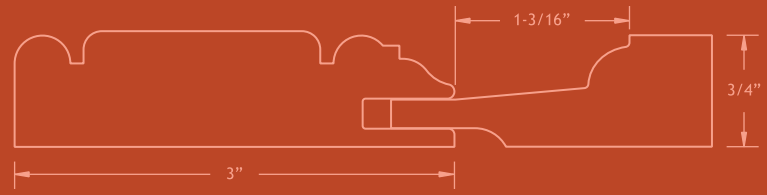
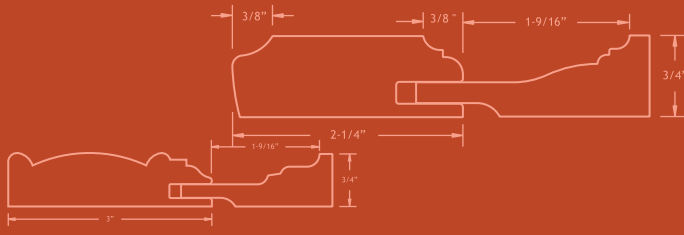

## Raised Panel Profiles

**GZ** Pnl-06  
Usage Group A  
Available in Flat Back

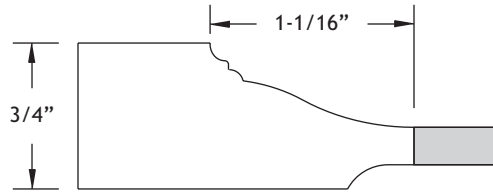

Minimum Panel Width = 2-7/8"

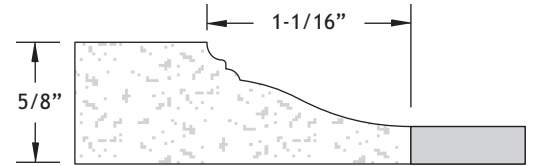

Pnl-07  
Usage Group A  
Available in Flat Back

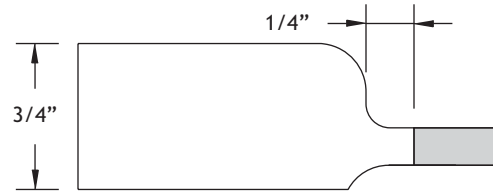

Minimum Panel Width = 2"

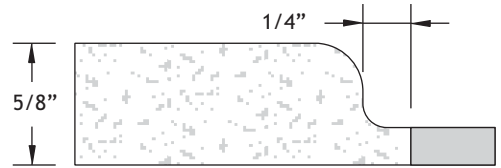

Pnl-09  
Usage Group A

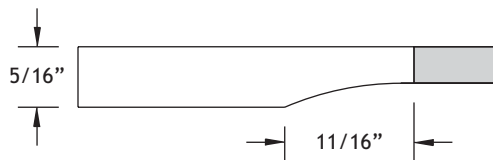

Minimum Panel Width = 1-1/2"

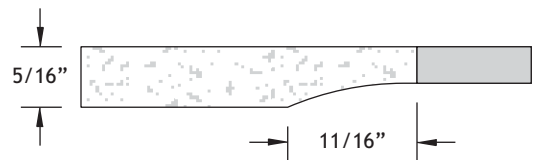

Pnl-10  
Usage Group A  
Available in Flat Back

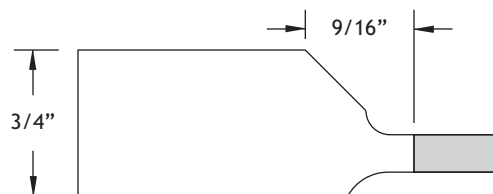

Minimum Panel Width = 1-7/8"

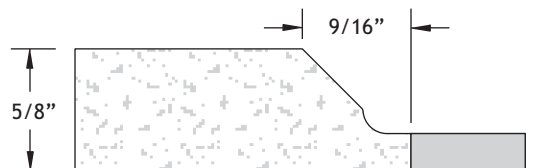

## Solid Panel Profile

## MDF Panel Profile

**Pnl-16**  
**GZ** Usage Group A  
 Available in Flat Back

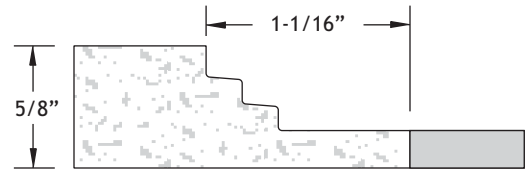
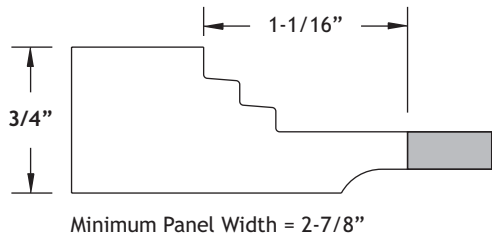

**Pnl-20**  
 Usage Group B

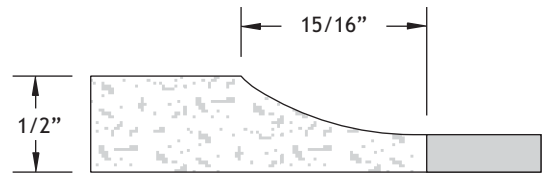
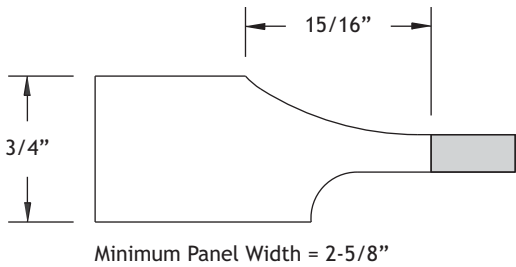

**Pnl-22**  
 Usage Group B

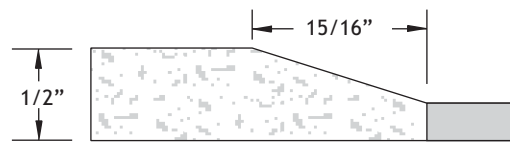
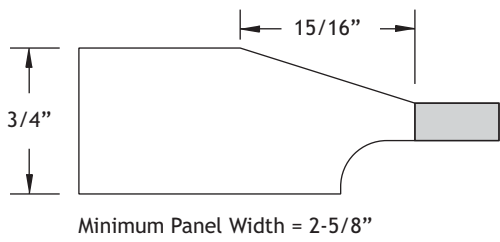

**Pnl-41**  
 Usage Group G

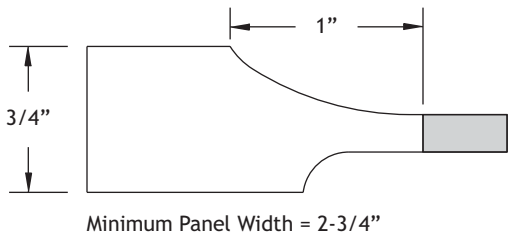

No MDF Option Available



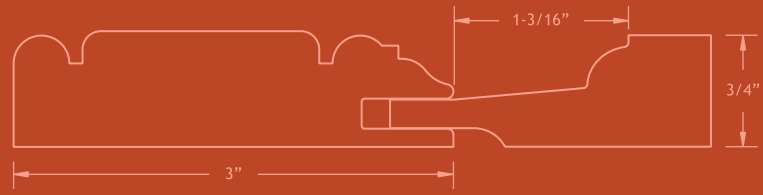
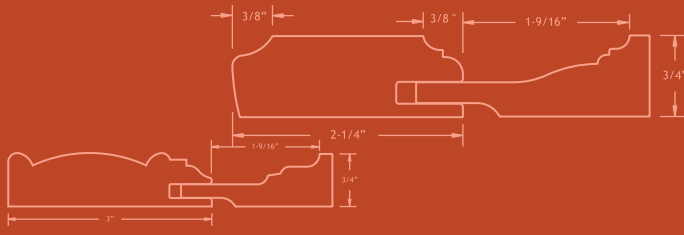

## Raised Panel Profiles

**Pnl-42**

Usage  
Group **G**

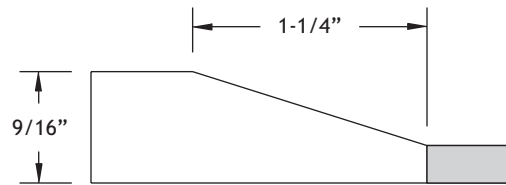

Minimum Panel Width = 3-1/4"

No MDF Option Available

**Pnl-54**

**GZ** Usage  
Group **A**

Available in  
Flat Back

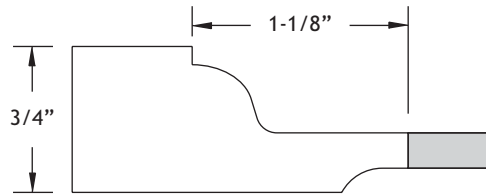

Minimum Panel Width = 3"

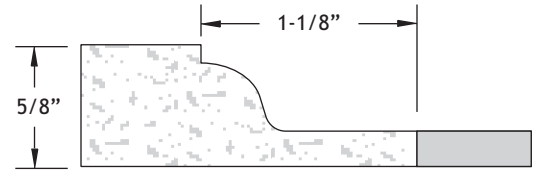

**Pnl-55**

**GZ** Usage  
Group **A**

Available in  
Flat Back

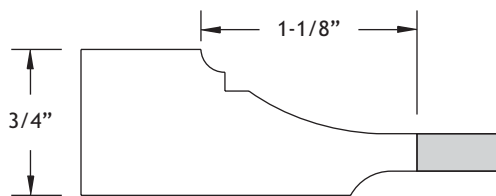

Minimum Panel Width = 3"

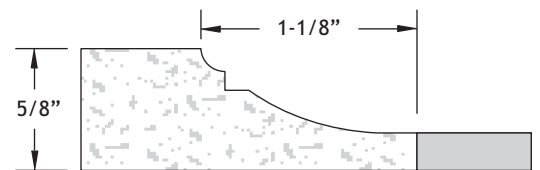

**Pnl-56**

**GZ** Usage  
Group **A**

Available in  
Flat Back

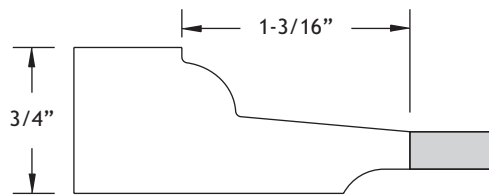

Minimum Panel Width = 3-1/8"

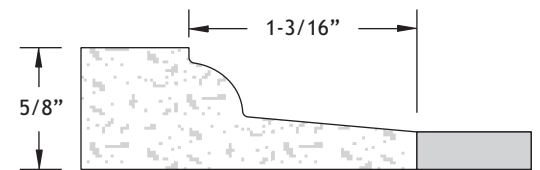

## Solid Panel Profile

## MDF Panel Profile

**Pnl-58**  
Usage Group **A**  
Available in Flat Back

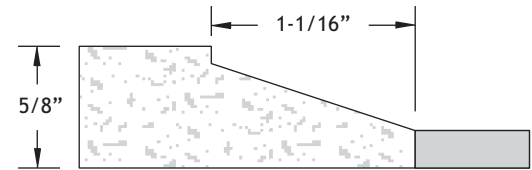
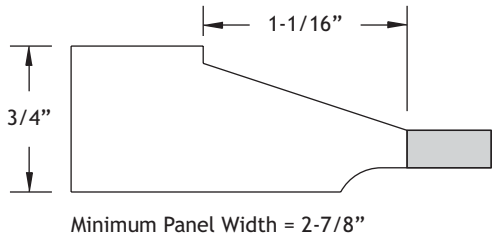

**Pnl-59**  
Usage Group **B**

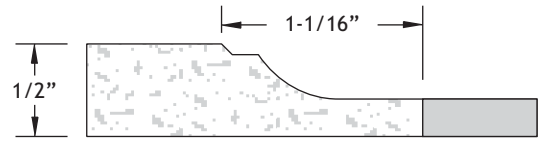
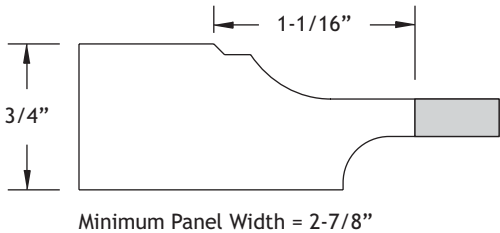

**Pnl-63**  
Usage Group **A**  
Available in Flat Back

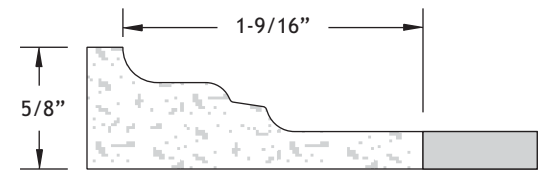
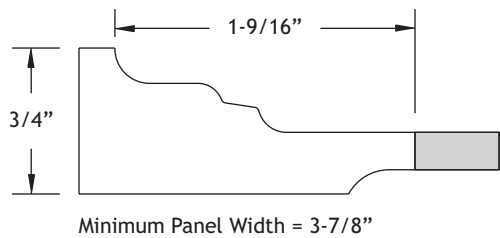

**Pnl-63DF**  
Usage Group **A**  
Available in Flat Back

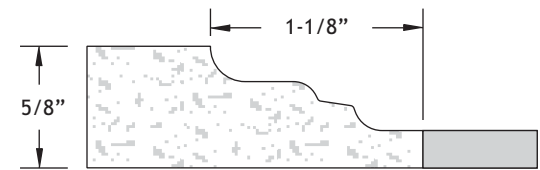
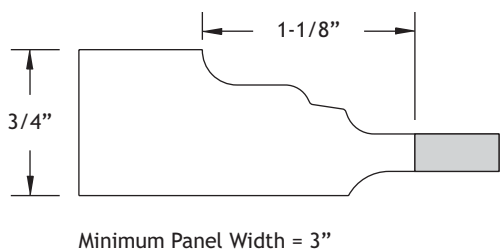

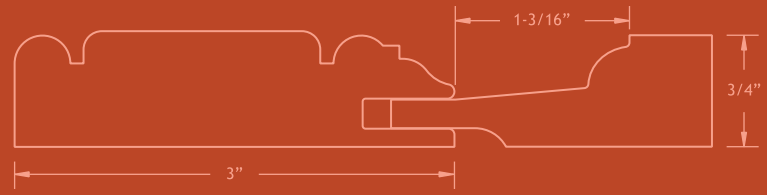
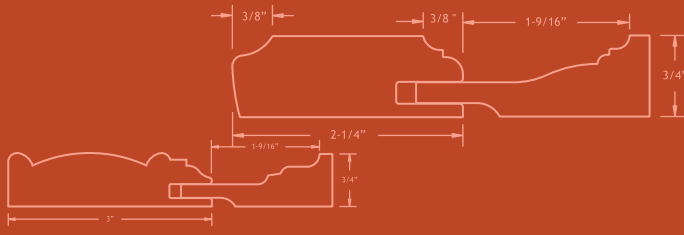

## Raised Panel Profiles

**Pnl-64**

Usage Group **A**

Available in Flat Back

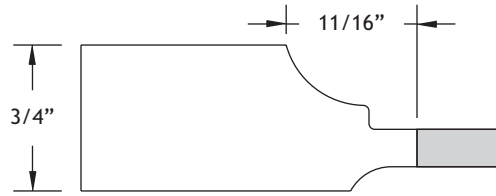

Minimum Panel Width = 2-1/8"

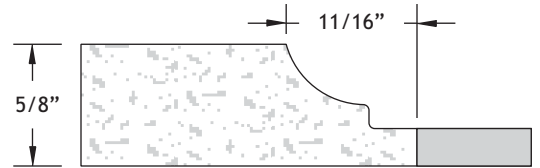

**Pnl-67**

**GZ** Usage Group **A**

Available in Flat Back

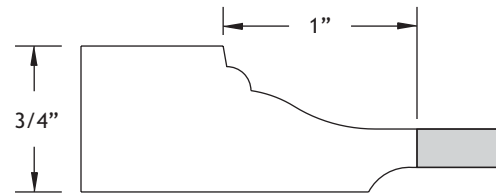

Minimum Panel Width = 2-3/4"

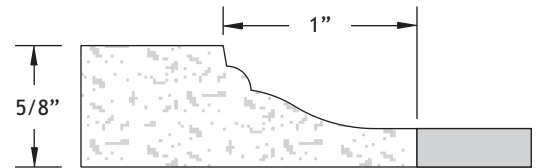

**Pnl-68**

Usage Group **A**

Available in Flat Back

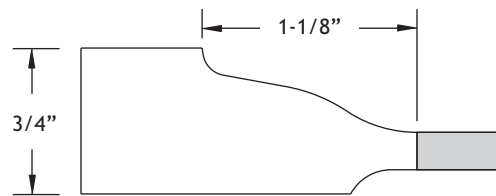

Minimum Panel Width = 3"

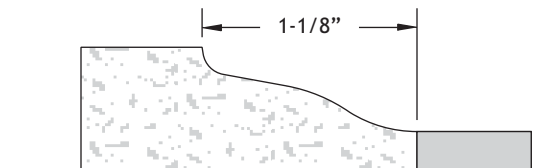

**Pnl-69**

**GZ** Usage Group **A**

Available in Flat Back

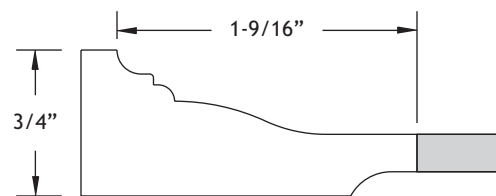

Minimum Panel Width = 3-7/8"

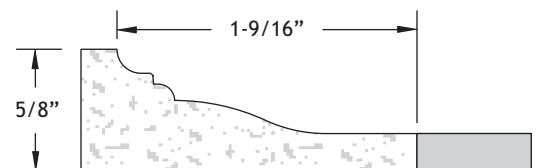

## Solid Panel Profile

## MDF Panel Profile

**Pnl-70**

Usage Group **A**

Available in Flat Back

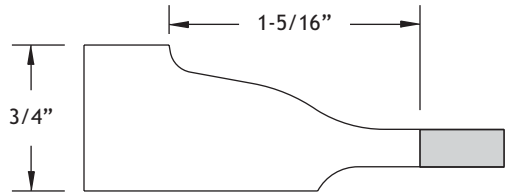

Minimum Panel Width = 3-3/8"

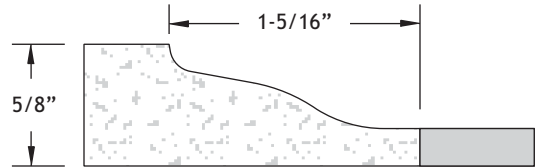

**Pnl-72**

Usage Group **A**

Available in Flat Back

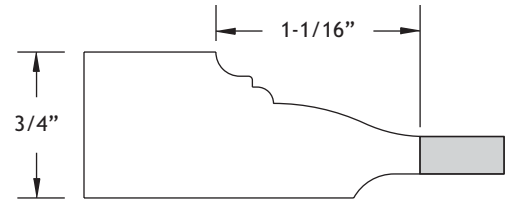

Minimum Panel Width = 2-7/8"

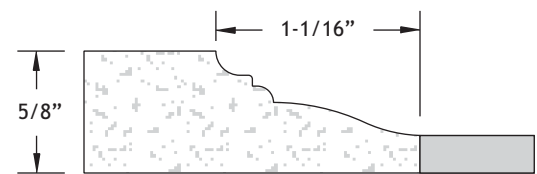

**Pnl-76**

Usage Group **A**

Available in Flat Back

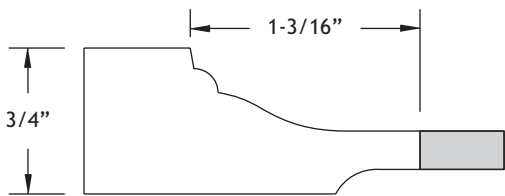

Minimum Panel Width = 3-1/8"

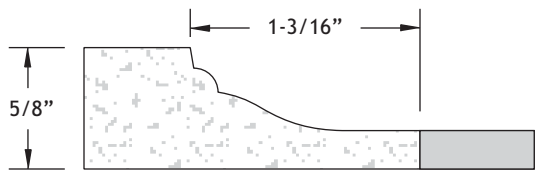

**Pnl-77**

Usage Group **A**

Available in Flat Back

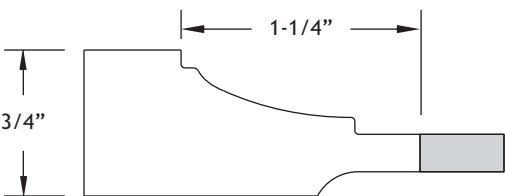

Minimum Panel Width = 3-1/4"

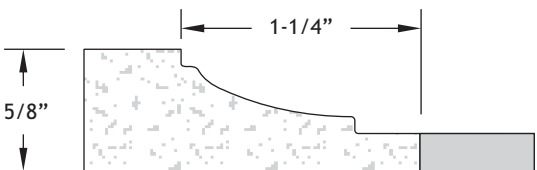

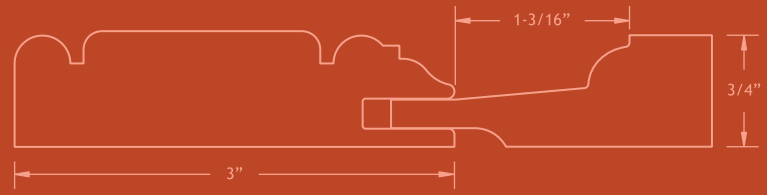
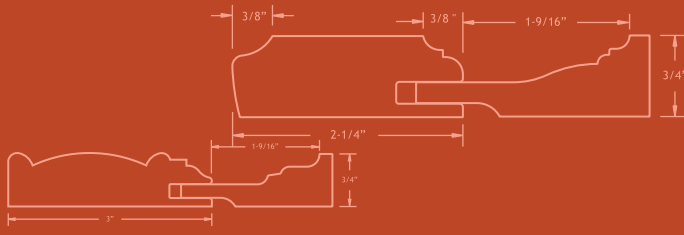

## Raised Panel Profiles

**Pnl-78**

**GZ** Usage Group A

Available in Flat Back

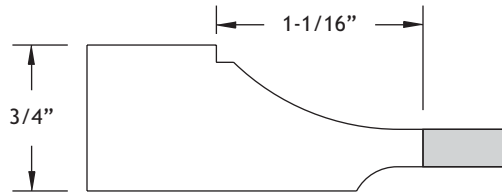

Minimum Panel Width = 2-7/8"

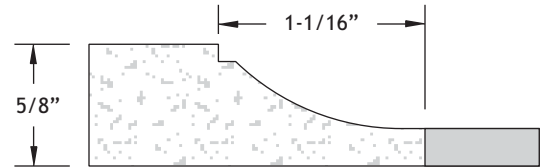

**Pnl-80**

**GZ** Usage Group A

Available in Flat Back

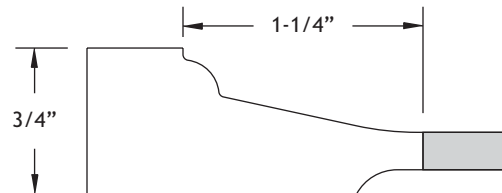

Minimum Panel Width = 3-1/4"

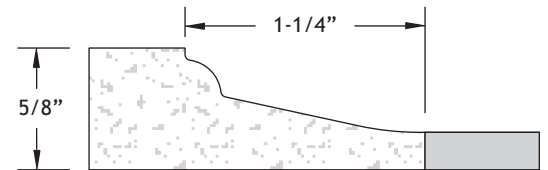

**Pnl-91**

Usage Group A

Available in Flat Back

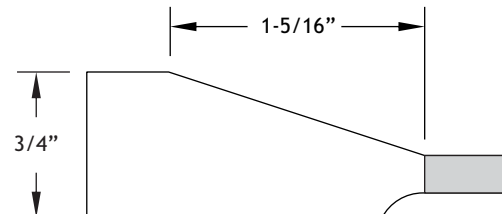

Minimum Panel Width = 3-3/8"

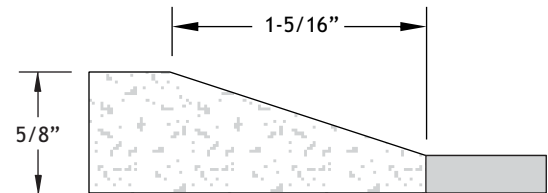

**Pnl-15**  
Usage Group **B**

**Works With P-3**

## Solid Panel Profile

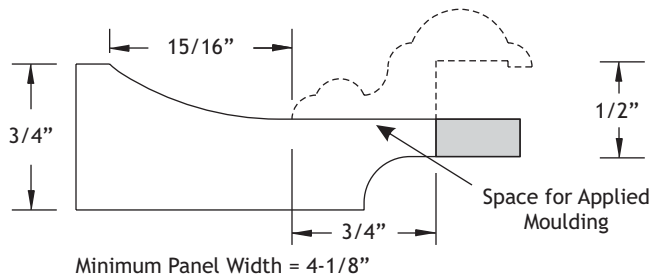

## MDF Panel Profile

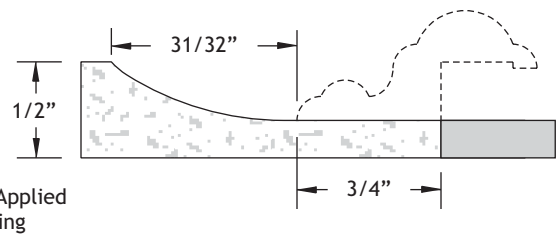

**Pnl-79**  
Usage Group **B**

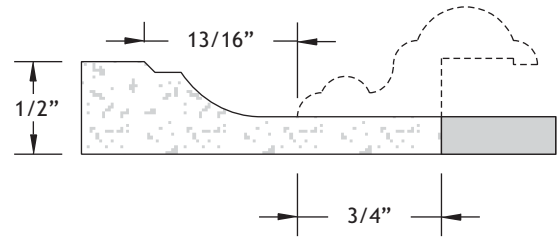
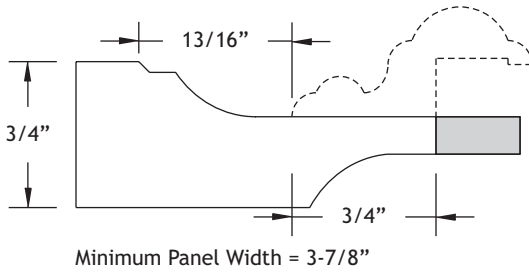

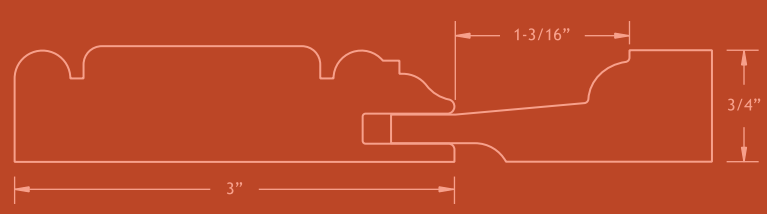
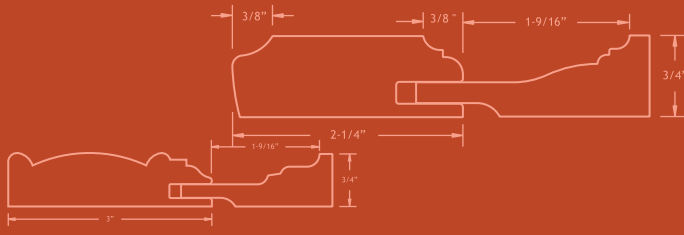

# Applied Moulding Raised Panel Profiles

**Pnl-27**

Usage Group **E**

Works With **P-19**

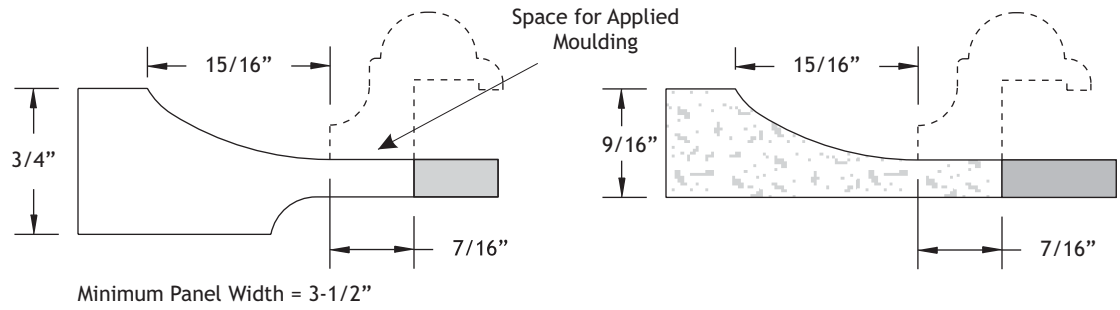

**Pnl-33**

Usage Group **E**

**GZ**

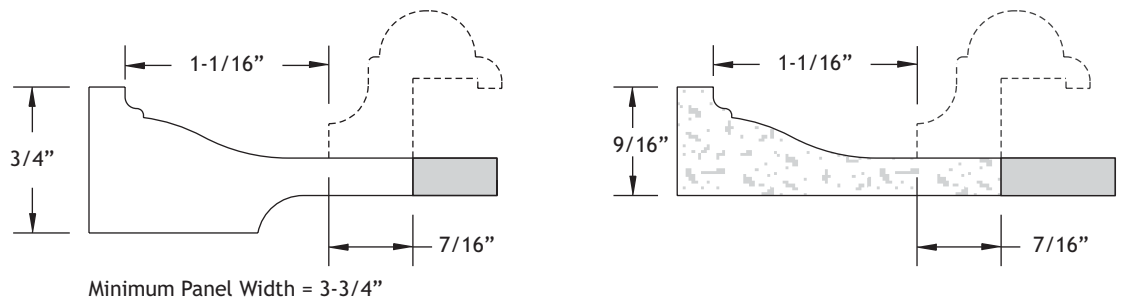

**Pnl-74**

Usage Group **E**

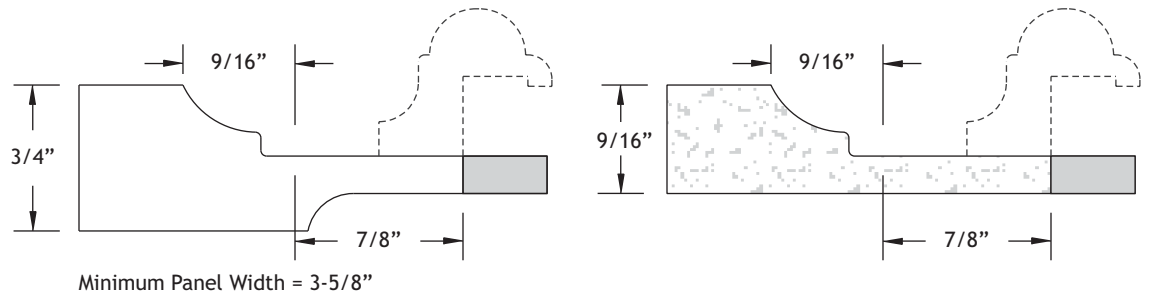

## Solid Panel Profile

## MDF Panel Profile

**Pnl-18**

Usage Group **A**

Works With **P-20**

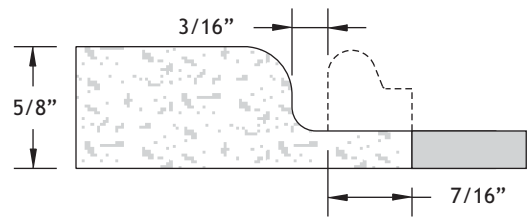
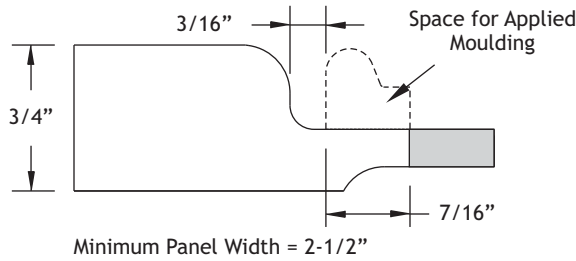

**Pnl-19**

Usage Group **A**

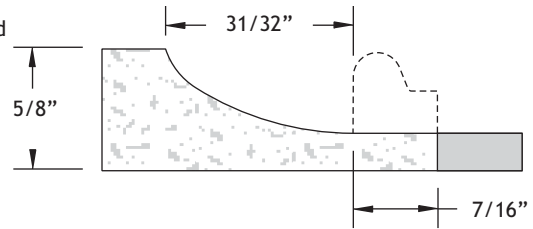
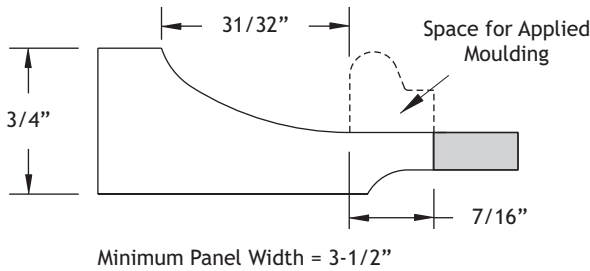

**Pnl-21**

Usage Group **A**

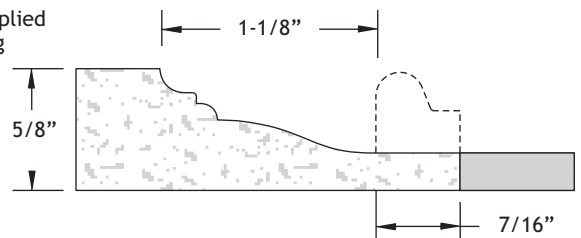
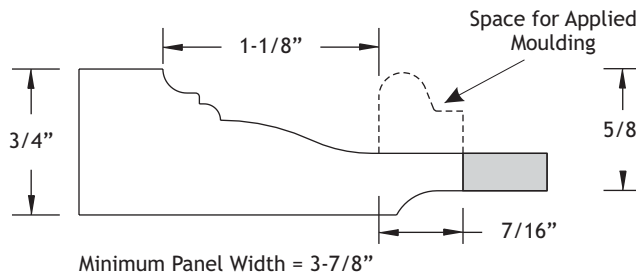

**Pnl-51**

Usage Group **A**

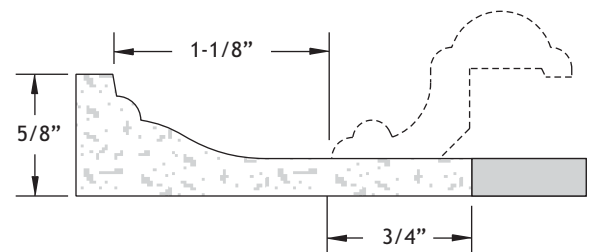
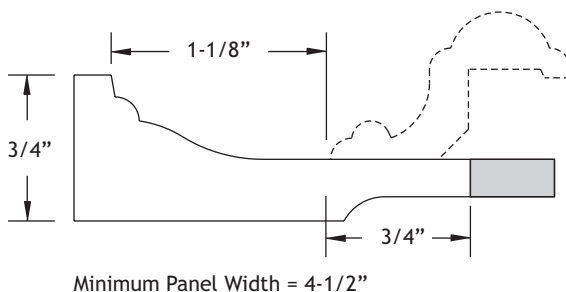



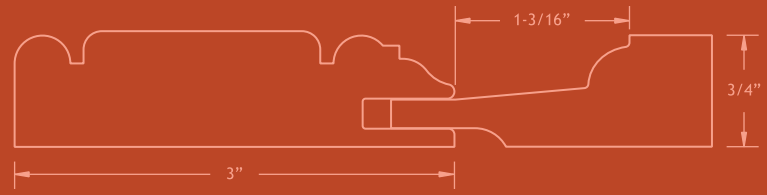
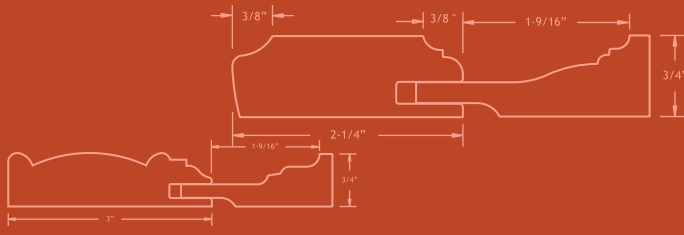

## Applied Moulding Raised Panel Profiles

Pnl-62

**GZ** Usage Group A

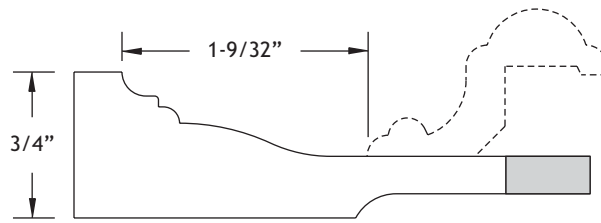

Minimum Panel Width = 4-3/4"

No MDF Option Available

Pnl-90

**GZ** Usage Group A

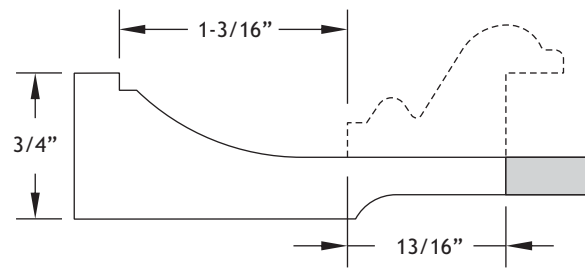

Minimum Panel Width = 4-3/4"

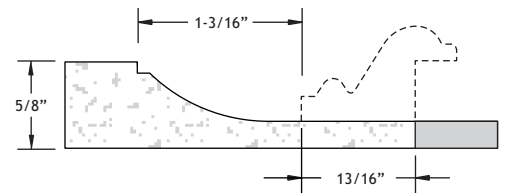

this drawing not to scale

Rev Raised  
Pnl-09  
Usage Group A

Optional E

Beaded

GZ Usage Group A

Optional E



V-Grooved

GZ Usage Group A

Optional E



## Solid Panel Profile

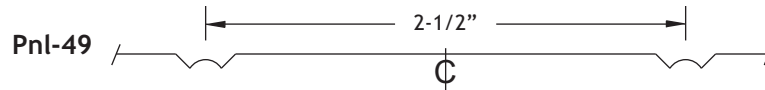
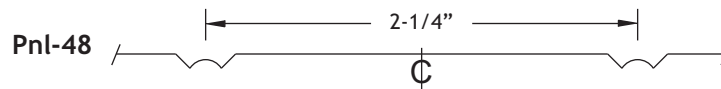
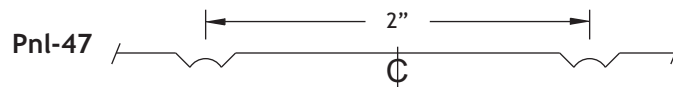
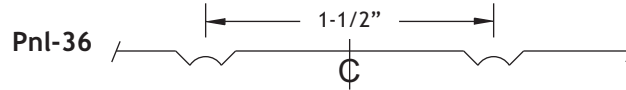
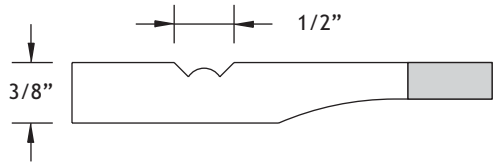
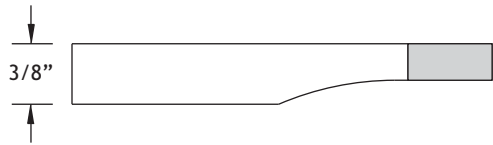

## MDF Panel Profile

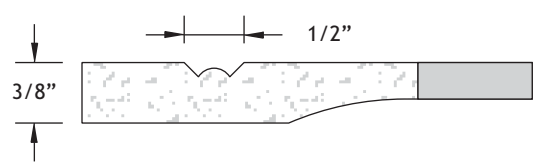
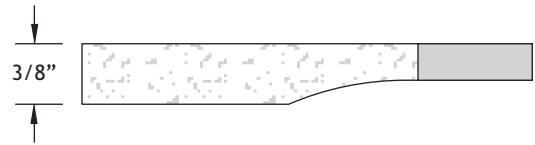

### Note:

Order Panel Number required to obtain the appropriate Bead Spacing desired.

All Beading starts with the Space centered on the panel.

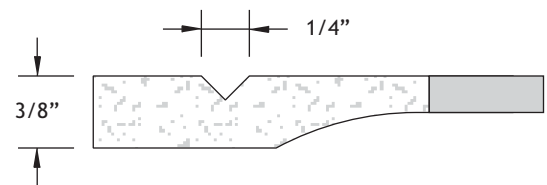
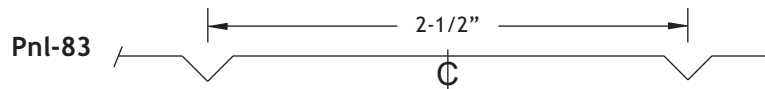
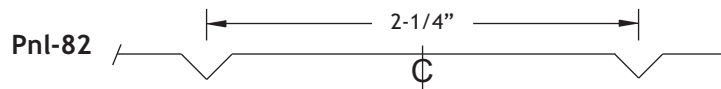
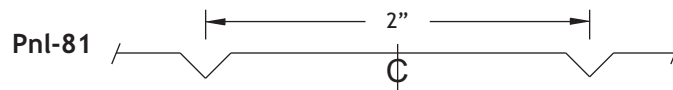
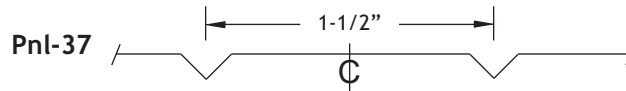
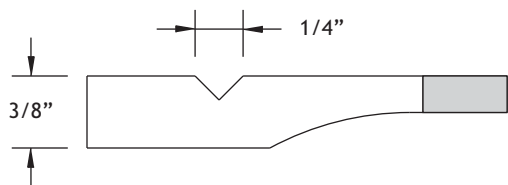

### Note:

Order Panel Number required to obtain the appropriate V-Groove Spacing desired.

All V-Groove spacing starts with the Space centered on the panel.

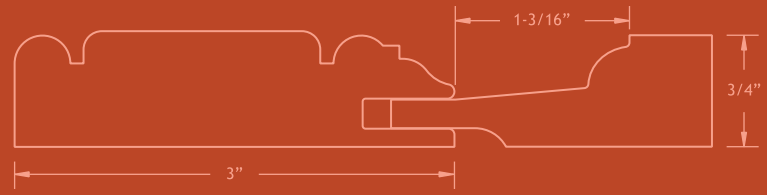
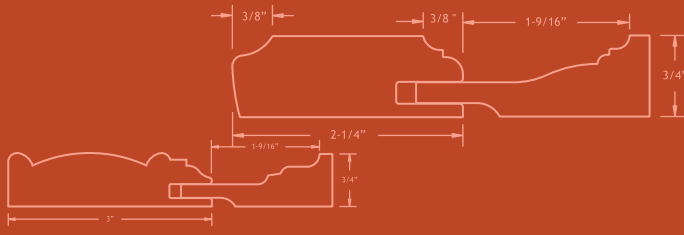

## Reverse Raised Panel Profiles

Rev Raised  
Pnl-04  
Usage Group B

Beaded

GZ Usage Group B

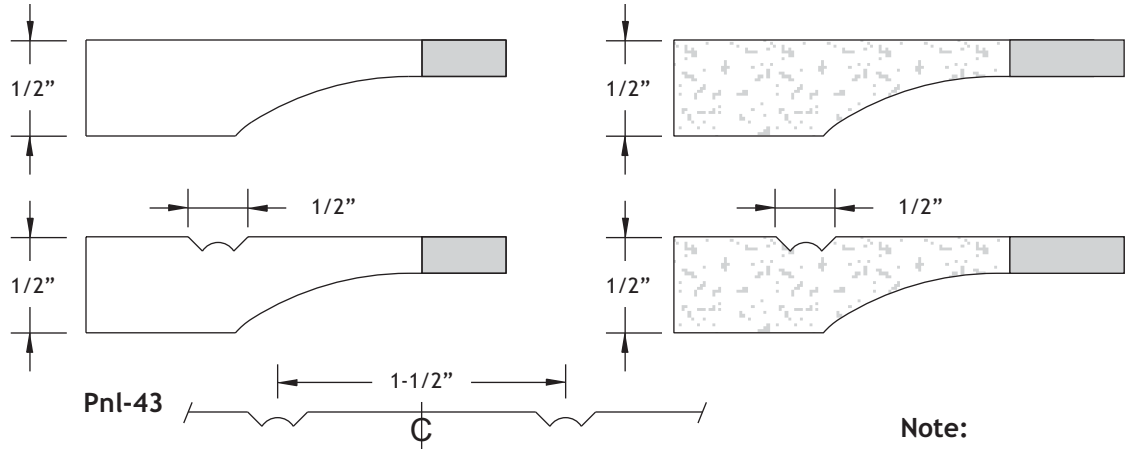

Pnl-43

Pnl-84

Pnl-85

Pnl-46

**Note:**

Order Panel Number required to obtain the appropriate Bead Spacing desired.

All Beading starts with the Space centered on the panel.

V-Grooved

GZ Usage Group B

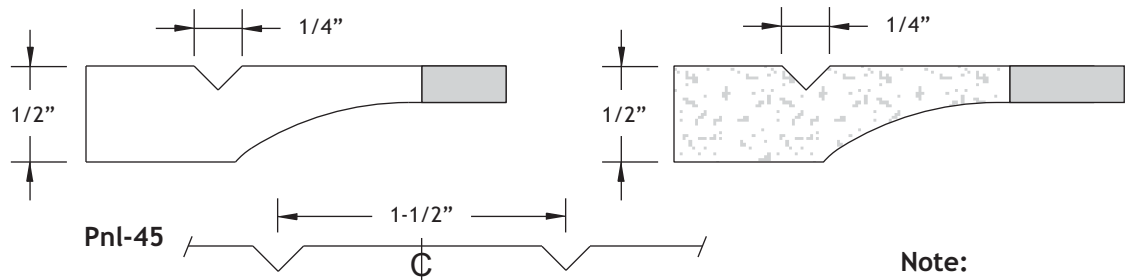

Pnl-45

Pnl-86

Pnl-44

Pnl-50

**Note:**

Order Panel Number required to obtain the appropriate V-Groove Spacing desired.

All V-Groove spacing starts with the Space centered on the panel.

# Edge Details

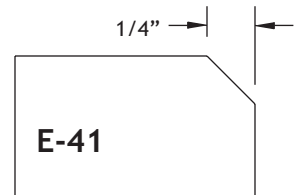
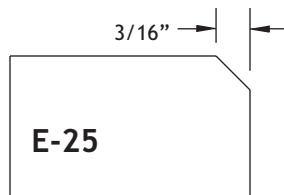
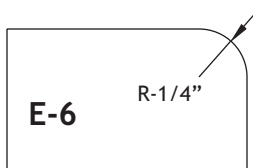
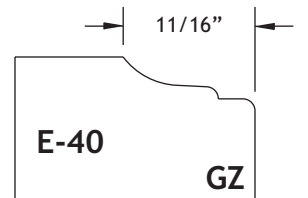
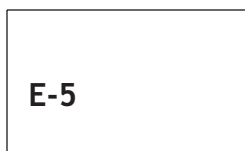
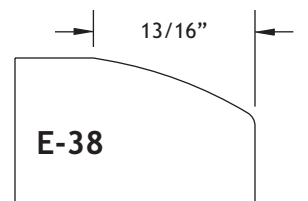
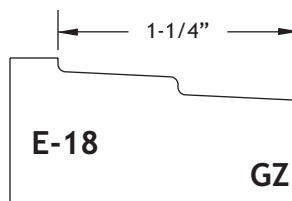
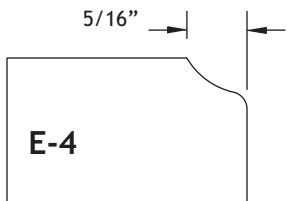
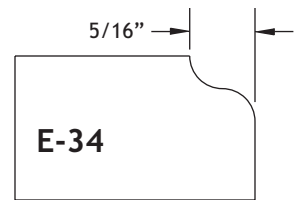
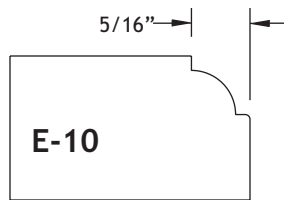
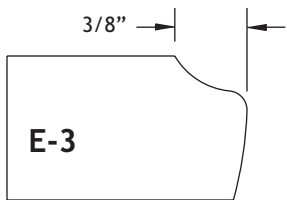
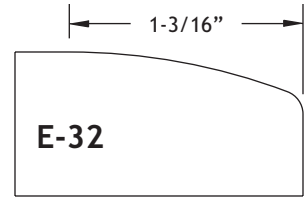
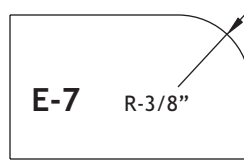
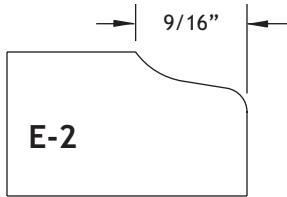

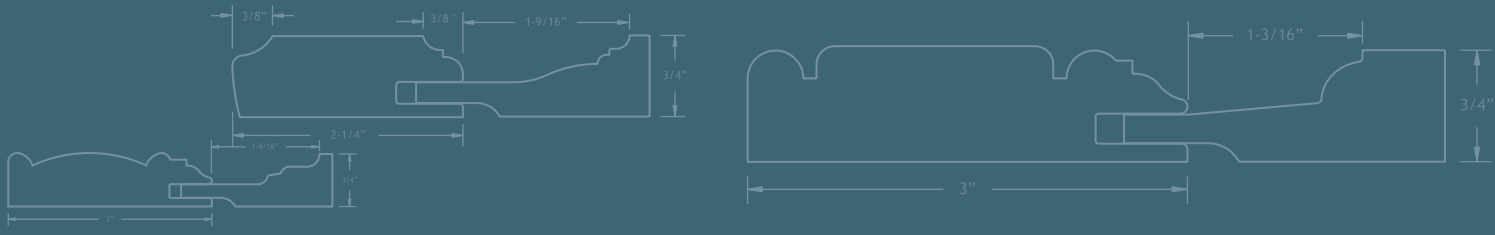

# Standard Edge Details

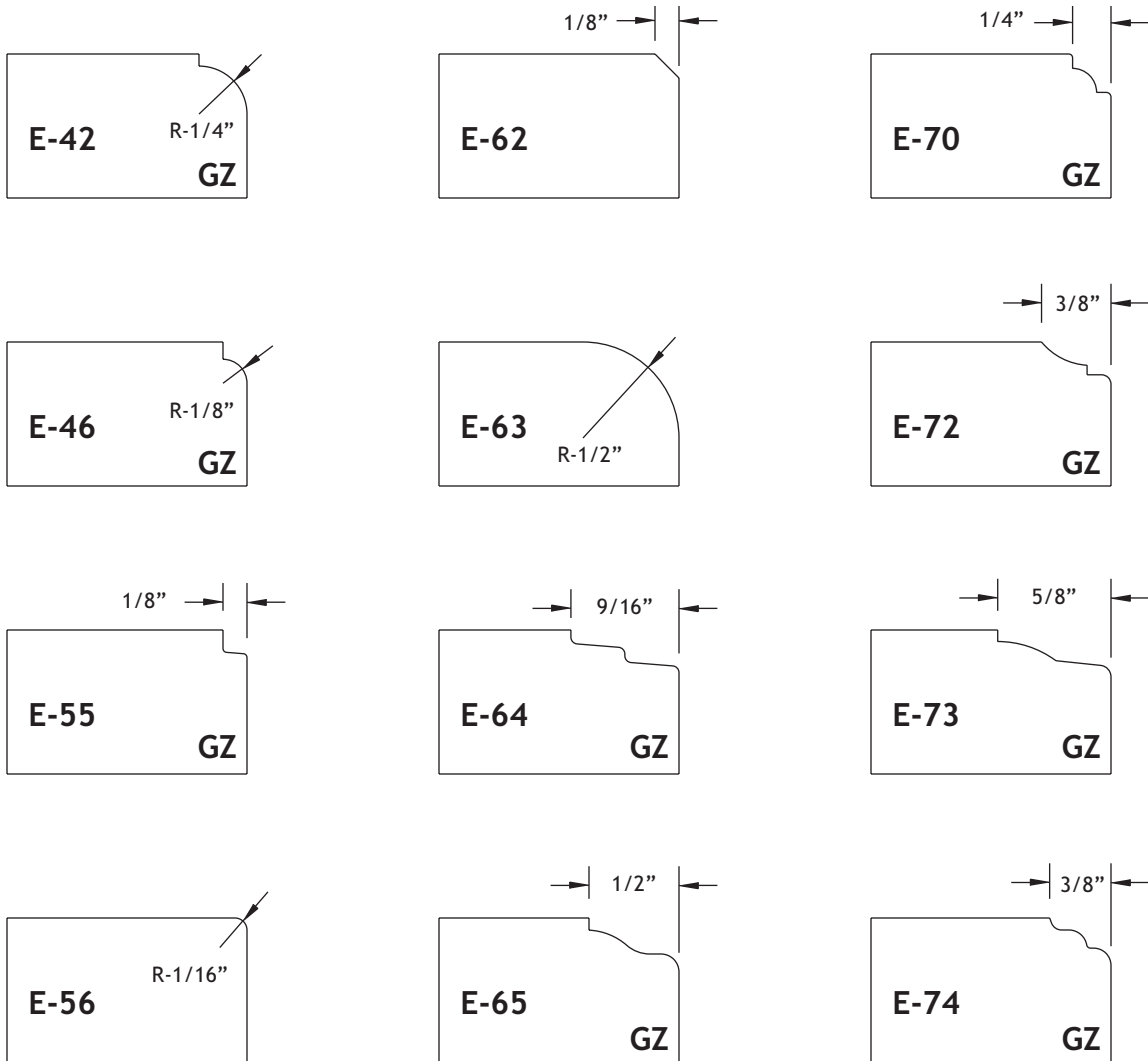

**Please Note:**

Added Fingerpulls, Hinge Preps and Radiused Corners are available for most of these edges. Please see the Options & Accessories section of the PureWood™ catalog.

## Finger Pull Edges

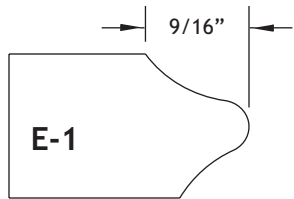

Euro Hinge Prep not available

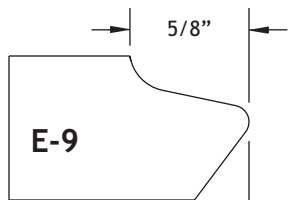

Euro Hinge Prep not available

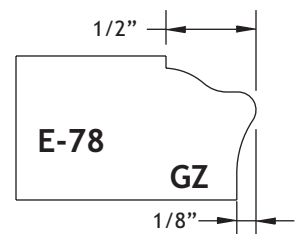
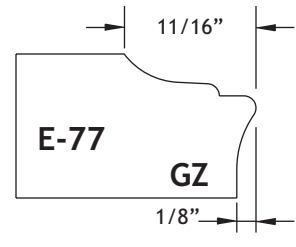
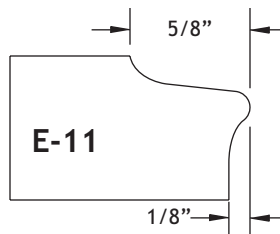
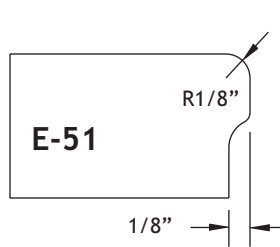

Please Note for these edges-Minimum Euro Hinge Prep Offset- 3.5mm

## Raised Drawer Front Edges

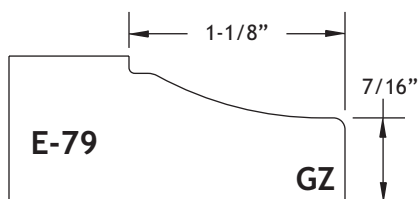
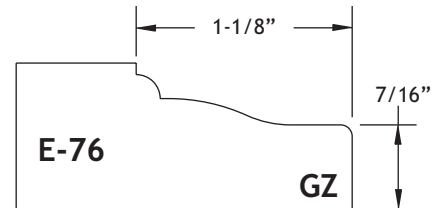
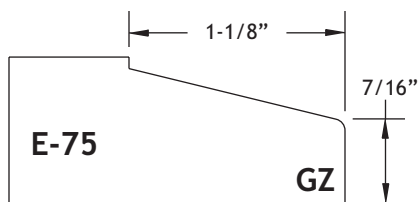

**Please Note:**

Raised Drawer Front Edges are available on #900 Solid Classic Drawer Fronts only. These edge will not work on Doors.





2900 Pringle Road SE, No. 150  
Salem, OR 97302

[sales@cabdoor.com](mailto:sales@cabdoor.com)

**cabdoor**

[www.cabdoor.com](http://www.cabdoor.com)



1-800-800-9382